

LK425K-41/A

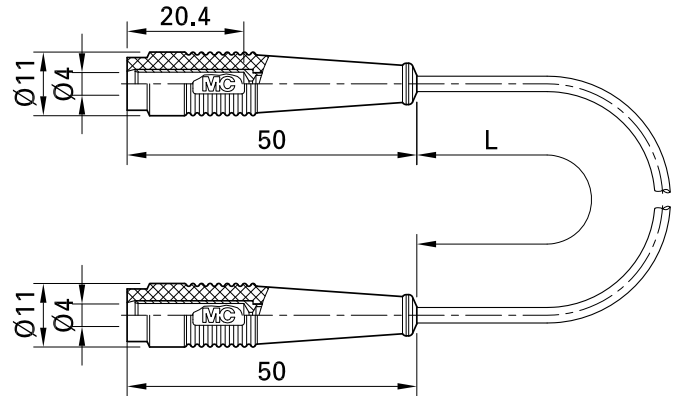

Item number 64.1024-*

Highly flexible, with Ø 4 mm rigid sockets on both ends.

Technical data	
Diameter of plug system	4 mm
Rated Values	30 V, 32 A / 60 V, 32 A
Surface treatment electrical contact	Au
Base material electrical contact	CuZn
Standard color(s) *	21 22
Optional color(s)	23 24 25 27 28 29
Lead lengths <input type="text"/>	100 cm
Lead insulation	PVC
Lead cross section	2,5 mm ²
Test accessory acc. to	IEC EN 61010-031
User-Information	I 099