

Round connectors single-pole, insulated, up to 1000 A

Energy supply | Single-pole industrial connectors

EN



STÄUBLI ELECTRICAL CONNECTORS

Connections for Life



Stäubli, as the international technology leader, offers innovative mechatronics solutions in its four divisions: Electrical Connectors, Fluid Connectors, Robotics, and Textile. At Stäubli Electrical Connectors, we develop advanced connection solutions based on the reliable MULTILAM contact technology.

Together for reliable and safe connections

We know that you entrust us with the functionality of your applications and we work hard to ensure this every single day. Thanks to our high level of expertise, our extensive experience and the multiple successful co-operation with our partners, numerous new developments have originated at Stäubli Electrical Connectors and subsequently have become worldwide standards. This includes our MC4 connector portfolio for which we are today the global market

We create connections for life – and our customers are at the center of these connections. We are convinced that solid and stable partnerships directly contribute to our mutual success.

We take on the needs of our partners and deal with the most extraordinary challenges. As a result, we always create, sell and

leader in photovoltaic. As the Stäubli original, the MC4 represents the result of our constant quest for innovation, quality and safety.

Further examples are the CombiTac modular connector system or the Quick Charging Connector (QCC) for automatic charging systems.

We ensure connections for life together with our long-standing customers in a wide range of industries from renewable energies, power transmission and distribution and E-mobility to industrial automation applica-

support reliable and long-lasting products for markets with the highest productivity and safety requirements in close cooperation with our customers.

tions, railway and welding automation, test and measurement and medical devices.

Thus, developing reliable, efficient and safe solutions based on our proven MULTILAM contact technology, which guarantees a high service lifetime in addition to highly efficient power transmission.

Applications and advantages

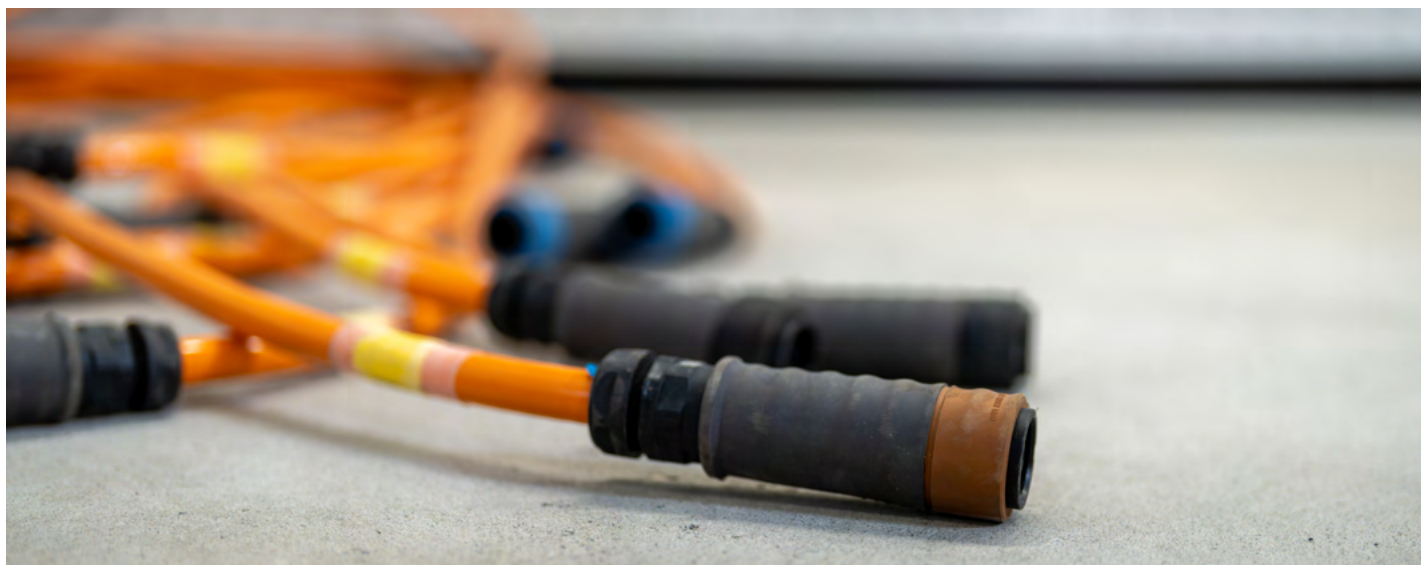

These round connectors from Stäubli Electrical Connectors are designed for use in the low-voltage range of temporary power supply, as well as for emergency power suppliers or in industrial environments such as plants, aggregates, or test fields.

Due to their robust design and reliable safety features, they are ideally suited in particular for applications with high requirements under harsh conditions.

For applications in sensitive EMV environments, the shielded variants are used.

Proven MULTILAM contact technology for reliability and safety:

- Highest current-carrying capacity
- Suitable for use to AC 1000 V/DC 1500 V
- High durability (to 5000 mating cycles)

- Plug-and-play bayonet locking
- Mechanical and color coding options

Application example: High-performance connectors ensure an uninterrupted power supply.



Contents

Page 6	Introduction	Page 36	21BV Connectors <ul style="list-style-type: none">• Type overview• Panel receptacle sockets• Surface mounting receptacle• Couplings• Accessories/tools
Page 8	Overview	Page 44	Shielded Connectors <ul style="list-style-type: none">• Panel receptacle socket and plug 16BV-GS• Sockets and panel receptacle plugs 21BV-GS• Accessories/tools
Page 10	Function of the bayonet locking	Page 52	Crimping
Page 11	Coding	Page 54	AxiClamp
Page 12	Overview accessories	Page 56	Technical data
Page 14	10BV Connectors <ul style="list-style-type: none">• Applications• Type overview• Panel receptacle socket• Surface mounting receptacle• Couplings• Accessories/tools	Page 66	Derating diagrams
Page 24	16BL Connectors <ul style="list-style-type: none">• Type overview• Applications• Panel receptacle socket• Surface mounting receptacle• Couplings• Accessories/tools	Page 69	Index

General information

Color code

For items which are available in multiple colors, write the two-digit color code after the order number instead of the "*" character indicated in the catalog.

20	green-yellow	26	violet
21	black	27	brown
22	red	28	grey
23	blue	29	white
24	yellow	30	orange
25	green	31	pink

Changes / disclaimers

All data, illustrations, and drawings in the catalog have been carefully checked. They correspond to our experiences to date, but no responsibility can be accepted for errors. We also reserve the right to make modifications for design and safety reasons. It is therefore advisable not to rely exclusively on the catalog data for designs that incorporate our components, but to consult us to ensure that the most recent data is used. We shall be pleased to advise you.

Copyright

The use of this catalog for any other purpose, in whatever form, without our prior written consent is not permitted.

RoHS ready

Directive 2011/65/EU on the restriction of the use of certain hazardous substances in electrical and electronic equipment.

Symbols



Accessories or special tools exist for this product



The assembly instruction MA000 is available for this product

INTRODUCTION

Proven reliability

The single-pole connectors from Stäubli guarantee maximum operational reliability, compliance with international standards and improved performance for easier operation. They are suitable for use under extreme en-

vironmental conditions and are characterized by a long service life.

The specification varies depending on the type and can be seen in the technical data.

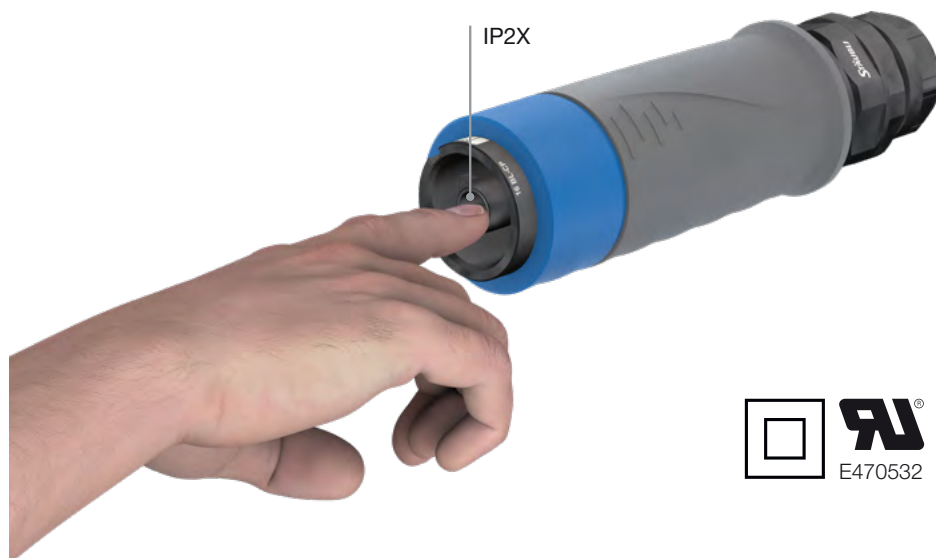

IP2X



Safety and conformity

Our connectors were developed according to **international standards** and offer, among other things:

- **IP2X** touch protection
- Double (reinforced) **class II insulation**

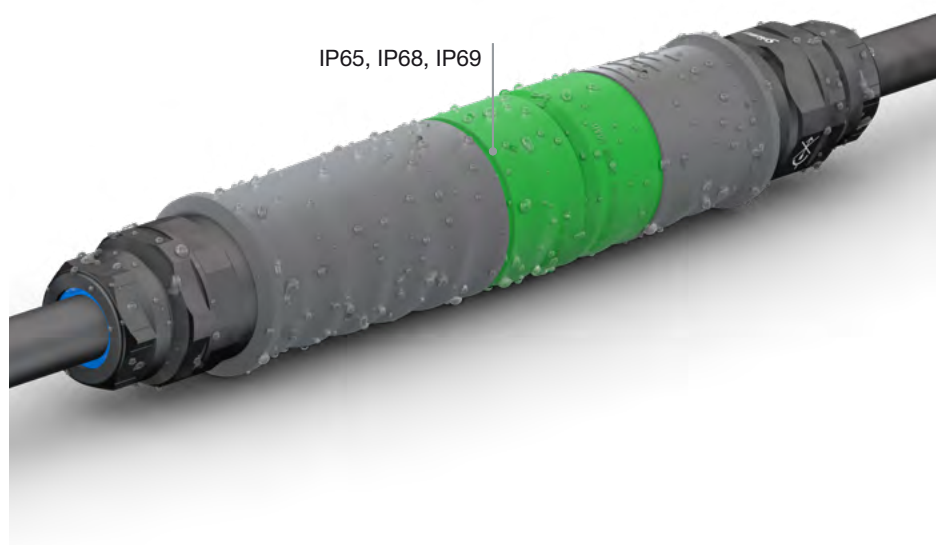

IP65, IP68, IP69

Performance and operation

Depending on the model, the universal connector solution for temporary power supply as well as for industrial applications from Stäubli offers:

- **High current-carrying capacity of up to 1000 A**
- Increased degree of protection: **IP65, IP68, IP69** according to IEC 60529
- High temperature range, from **-60 °C to +120 °C**
- Thorough test procedures, e.g. **salt spray test**

More safety features

Excellent mechanical features combined with proven MULTILAM contact technology make the single-pole connectors the right connection solution when it comes to safety, resistance and durability.

The compact design of the connector and the wide range of cable connection options facilitate commissioning and integration into existing applications.

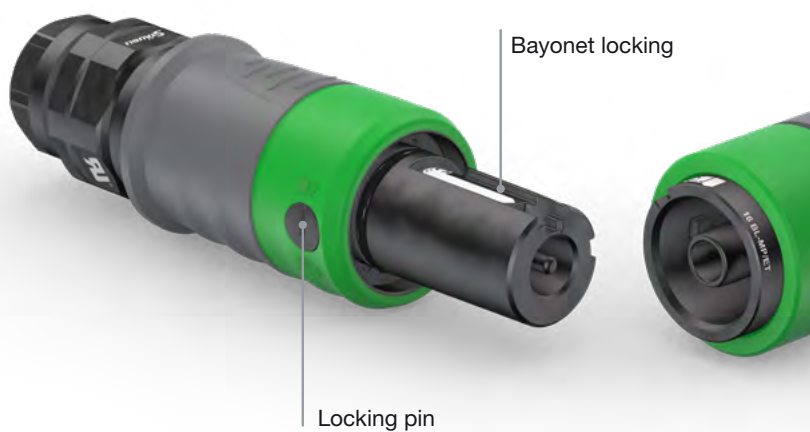

Robustness and longevity

- **Up to 5000 mating cycles**
- **The patented bayonet locking** makes it easier to connect and disconnect
- **A locking pin or locking ring** prevents accidental disconnection – the connection can only be unlocked with tools.
- **Colored and mechanical coding** increase safety



Easy handling, quick commissioning

The compact dimensions ensure user-friendly operation as well as space savings when integrated into devices. In addition, our single-pole connectors offer:

- Quick and easy mounting and dismantling
- AxiClamp or conventional crimp connection possible (AxiClamp see page 54)

OVERVIEW

Single-pole round connectors, up to 1000 A

The single-pole high-current round connectors are characterized by easy and safe use, robustness and durability. Touch protection as well as high IP protection ensure user safety and enable use in harsh environments. Thanks to the unique MULTILAM contact technology, it scores with unrivaled electrical and mechanical features and has excellent performance thanks to first-class

and constant current-carrying capacity and minimal contact resistance. Its design guarantees extremely durable and reliable electrical contacts; this series allows up to 5000 mating cycles.

The single-pole round connectors are ideally suited for demanding applications, such as in the utilities sector for emergency power

supply, in test fields or in onshore and offshore facilities.

For applications where special requirements for electromagnetic compatibility must be met, we offer shielded connectors.











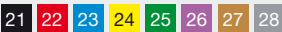
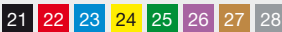

Overview		 
	Round connectors 10BV	Round connectors 16BL
Rated current	250 A	to 630 A (IEC) to 380 A (UL)
Rated voltage	1000 V	AC 1000 V/DC 1500 V (IEC) AC/DC 600 V (UL)
Contact diameter	Ø 10 mm	Ø 16 mm
Conductor cross-section	6 mm ² – 70 mm ²	70 mm ² – 240 mm ²
Cable connection	AxiClamp	Crimping/AxiClamp
Mating cycles	to 5000	to 5000
Degree of protection, mated condition unmated condition	IP65 IP2X	IP65, IP68 (1 m, 1 h), IP69 IP2X
Temperature range	-40 °C ... +90 °C	-40 °C...+120 °C
Bayonet locking	90°, with bayonet locking system	45°, with bayonet locking system
Mechanical coding	C1 to C5	C1 to C7
Color coding		
Locking	Locking ring (optional)	Locking pin

Accessories

Microswitch	✓	✓
Protective cover	✓	✓
Fixing band		✓
Angled adapter	Upon request	✓
UL listed component	Upon request	✓

Features:

- Up to 5000 mating cycles
- IP2X touch protection
- Depending on model up to IP68/IP69
- AC 1000 V/DC 1500 V
- 250 A to 1000 A
- Bayonet locking system
- Large selection of color coding
- Mechanical coding

		
Round connectors 21BV	Shielded connectors 16BV-GS	Shielded connectors 21BV-GS
1000 A	530 A	600 A
1000 V	1000 V	1000 V
Ø 21 mm	Ø 16 mm	Ø 21 mm
150 mm ² – 400 mm ²	50 mm ² – 240 mm ²	240 mm ² – 300 mm ²
Crimping	Crimping	Crimping
to 5000	to 5000	to 5000
IP65, IP68, IP69 IP2X	IP65, IP67, IP69 IP2X ¹⁾	IP65, IP67, IP69 IP2X ¹⁾
-60 °C...+120 °C	-30 °C...+90 °C	-40 °C...+120 °C
45°, with bayonet locking system	90°, with bayonet locking system	45°, with bayonet locking system
C1 to C6	upon request, customer-specific	C1 to C6
		
Locking pin		
		
		
		
In-part, upon request		

¹⁾ IP65 and IP67 with protective cover also in unmated state

²⁾ Upon request, customer-specific

BAYONET LOCKING

Function of the bayonet locking



Plugging procedure

The plug-in connection comes with bayonet locking. For connecting, the plug and socket markings must face each other. Plug in the connector to the stop, then turn the socket 45° or 90° to the right, depending on the type, until the lock snaps in.

Test procedure

Check whether the lock is engaged by rotating it. Check by pulling whether the connection can no longer be disconnected in this position.

Unplugging procedure

To release, pull back the retractable sleeve of the socket side and turn the plug 45° or 90° to the left, depending on the type, until the markings axially face each other. Disconnect plug and socket.

Note

The larger the cross-section of the connected lead and the shorter the lead length, the greater the force required during the plugging and locking process.

CODING

For round connectors 10 – 21 mm

Mechanical coding

To avoid the risk of incorrect mating, up to 7 different mechanical codes (C1 to C7) are available depending on the type.

The coding differ in the arrangement of the guiding grooves and lugs.

The coding number is engraved on the plug next to the marking.

Only plugs and sockets with the same coding number can be plugged together.



Connectors	10BV	16BL	21BV	16BV-GS	21BV-GS
Coding options	5	7	6	–	6

Color coding

Up to 12 different colored encodings are available for faster identification and a more secure connection.

Various choices allow use in all applications (e.g. temporary power supply and industry) and in the colors used on site for wire markings.



Region	Phase 1 (L1)	Phase 2 (L2)	Phase 3 (L3)	Neutral conductor (N)	Protective conductor (PE)	Reserve
Coding recommendation	C1	C2	C3	C4	C5	C6 C7
Europe	●	●	●	●	●	–
USA (120 V/208 V/240 V)	●	●	●	●	●	–
USA (277 V/480 V)	●	●	●	●	●	
China	●	●	●	●	(●)	–

Color coding in accordance with HD 308 S2: 2001, IEC 60445:2017, NEC 2017.

OVERVIEW ACCESSORIES

A large selection of accessories



More safety features

Microswitch for monitoring the connection status:

- The status of the changeover contact changes when the plug is properly connected
- The user can be notified by connecting the microswitch to an additional warning indicator
- Corresponds to IEC 61984 requirements

Long service life

Stäubli offers protective cover for high ingress protection:

- Protection of the connector in unmated condition (against moisture, dust, mud, oil, chemicals, etc.)
- Increases both the safety and the durability of the MULTILAM contact elements

Optimized operation

For the 16BL connector we offer a 45° angled adapter for more flexibility:

- Compact size allows more cost-effective integration
- Ensures cable strain relief at the connector
- Easier connection and disconnection, especially for larger cables

Also optional on the 16BL is a fixing band specifically designed for attaching to the generator's cable reels. This guarantees safe mounting and easy handling.

OVERVIEW 10BV

Stäubli connectors 10BV

Technical data	
Rated voltage IEC	AC 1000 V/DC 1500 V
Rated current IEC	250 A ¹⁾
Degree of protection ^{2) 3)} , mated unmated	IP65 (ID/S..., IS...with flat seal) IP2X
Material insulation	PA
Material housing	CuZn (AG)
Temperature range	-40 °C ... +90 °C
Contact resistance	≤ 40 μΩ
Short-circuit current, 1 s/3 s	to 6.0 kA/to 3.4 kA
Peak withstand current	up to 25 A
Test voltage (50 Hz/1 min.)	6.6 kV
Rated impulse voltage, 1.2 μs/50 μs (kV)	8 kV
Overvoltage category/pollution degree	CATIII/3
Shielding	No
Conductor cross-section AxiClamp connection	6 mm ² – 70 mm ² 10 AWG – 2/0 AWG
Nominal-Ø pin/socket	10 mm
Withdrawal force/plugging force, when parts are new	40 N/175 N
Max. Tightening torque	10 N m
Mating cycles	to 5000
Mounting, ID/S10BV IS10BV	Housing and panels optional with angled adapter (upon request) Direct on busbars
Type of termination, KST/KBT10BV... ID/S.... IS...	AxiClamp Cable lug Busbar/contact block
Locking	Bayonet locking, 90°
Color codes	10
Mechanical codes	C1 to C5
In compliance with	IEC 60664-1, IEC 60529, IEC 60512-5-2, IEC 61238-1-1, IEC 61984

For additional technical information see pages 56 – 68

¹⁾ Depending on model - detailed information on pages 56 – 57

²⁾ Depending on the connector combination, in mated condition or with protective cover

³⁾ Surface mounting receptacle: not with microswitch and only with protective cover (does not apply to cable side)

Power supply with the help of a mobile generator and Stäubli round connectors



Types and connection options

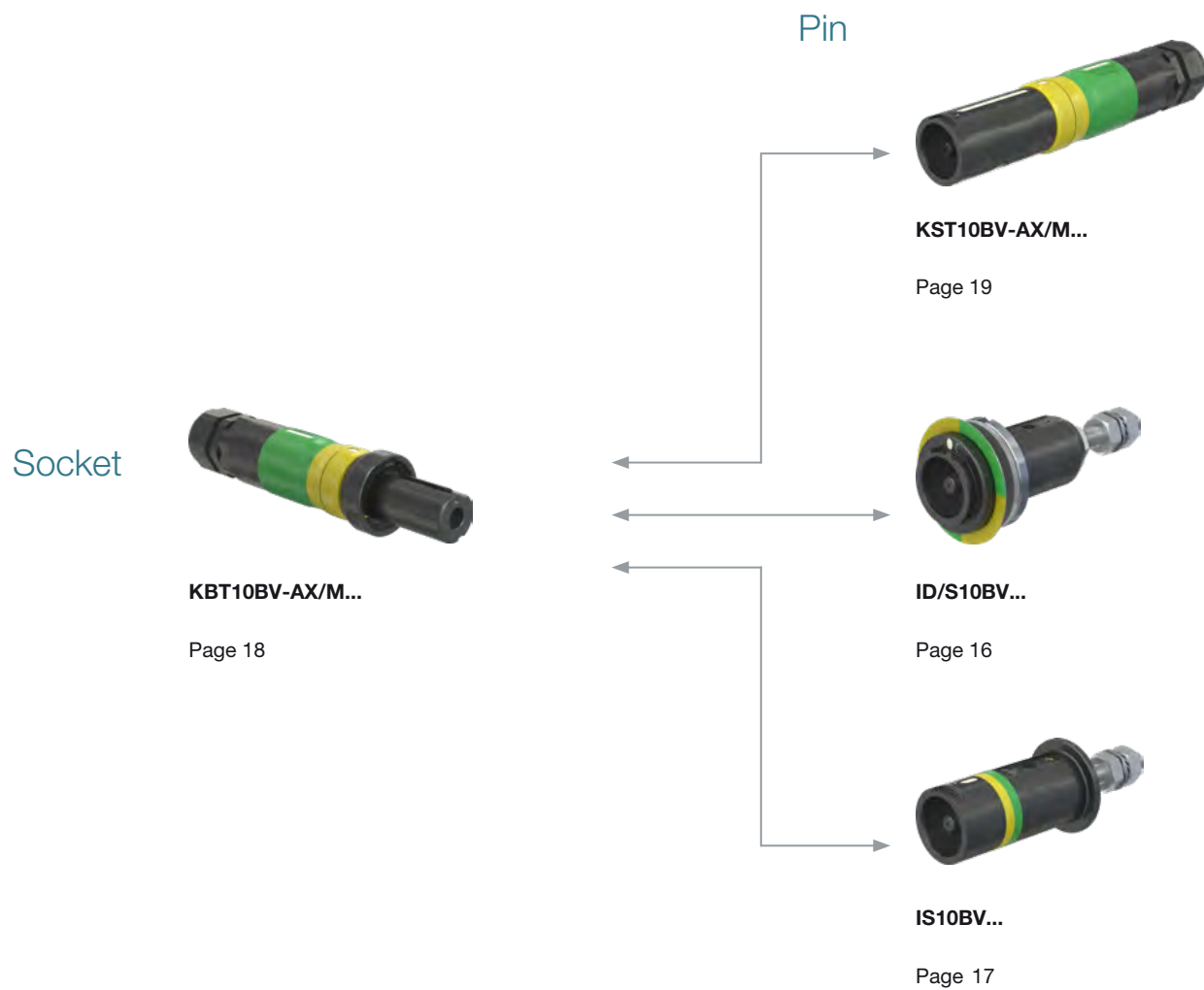

Notes about coding:

Only plugs with sockets that have the same coding number can be plugged in.

C1 = Standard code

PANEL RECEPTACLE SOCKET 10BV

Plug ID/S10BV

Panel receptacle socket with threaded connection M10

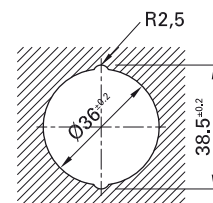
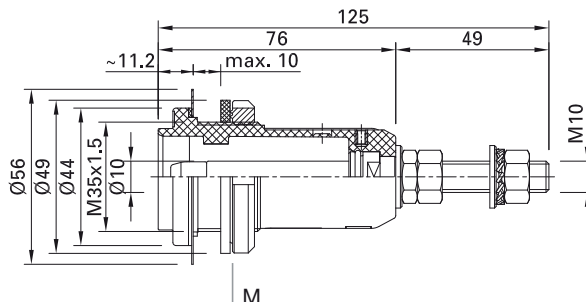
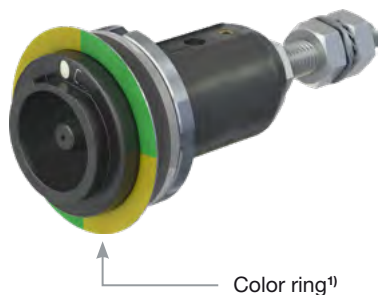

Drilling plan

Order No.	Type	Description	*Colors
14.0048C... ²⁾	ID/S10BV-C... ²⁾	Pin	

Accessories (please order separately)

14.5187-*	FR10	Color ring	
14.5189	ID10BV-WZ	Socket wrench SW17, to tighten ring nut (M), see page 23	
14.5252-*	PL-PC-1021SET	Protective cover, see page 20	
15.5809	VK-S10BV	Protective cover, see page 20	
14.0103	MS-S10BV	Microswitch, see page 21	



Assembly instructions MA046

www.staubli.com/electrical

* Please specify the color code

¹⁾ Please order color ring separately

²⁾ Add code number (C1 up to C5).

SURFACE MOUNTING RECEPTACLE 10BV

Plug IS10BV

Surface mounting receptacle with threaded connection M10



Colored tape

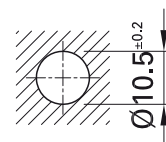
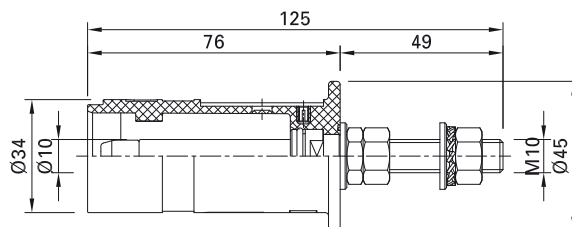

Drilling plan

Order No.	Type	Description	Colors
14.2020C... ¹⁾ -*	IS10BV-C... ¹⁾	Pin	

Accessories (please order separately)

14.5190	FDK10BV	Flat seal, for IP65 mounting on a surface, page 22
15.5809	VK-S10BV	Protective cover, page 20
14.0103	MS-S10BV	Microswitch, page 21



Assembly instructions MA047

www.staubli.com/electrical

* Please specify the color code

¹⁾ Add code number (C1 up to C5).

COUPLINGS 10BV

Sockets KBT10BV

With AxiClamp connection for CU class 5 and 6 cable¹⁾

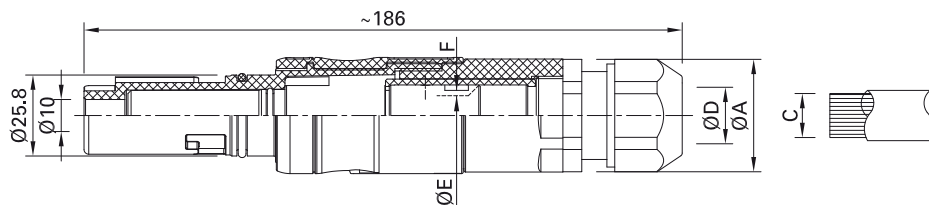
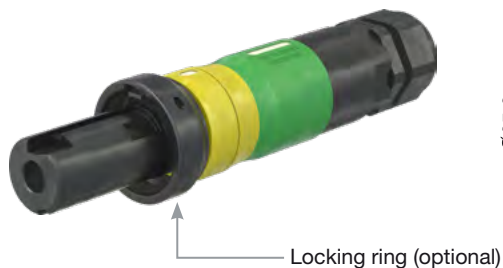

Order No.	Type	Dimensions		Conductor cross-section		Ø-range of the cable gland	Max. Ø conductor	SW of the AxiClamp sleeve	*Colors
		Ø A	C mm ²	C AWG	Ø D mm				
15.0644C... ²⁾ _*	KBT10BV-AX/M25/6-16-C... ²⁾	36	6 ³⁾ ; 10 ³⁾ ; 16	10; 8; 6	9 – 18	6	9		
15.0645C... ²⁾ _*	KBT10BV-AX/M25/25-35-C... ²⁾	36	25; 35	4; 2	9 – 18	8.5	12	20 21 22 23 24 25	
15.0646C... ²⁾ _*	KBT10BV-AX/M25/50-70-C... ²⁾	36	50; 70	1/0; 2/0	9 – 18	12.5	16	26 27 28 29	
15.0647C... ²⁾ _*	KBT10BV-AX/M32/50-70-C... ²⁾	46	50; 70	1/0; 2/0	13 – 25	12.5	16		

Accessories (please order separately)

15.5808	VK-B10BV	Protective cover, page 20
15.5807	VR10BV	Locking ring, page 22
15.0139	VR10BV-WZ	Tools for removing the locking ring, page 22
15.0138	GS33/42	Open-end spanner to tighten the cable gland, page 23



Assembly instructions MA048

www.staubli.com/electrical

* Please specify the color code

¹⁾ In accordance with IEC 60228 (DIN VDE 0295), see page 55

²⁾ Add code number (C1 up to C5).

³⁾ Increase the outside cable diameter (e.g. with heat shrink tubing) so that the cable gland clamps and seals sufficiently

Plugs KST10BV

With AxiClamp connection for CU class 5 and 6 cable¹⁾

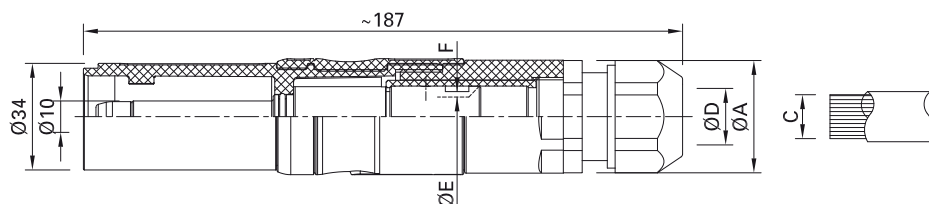
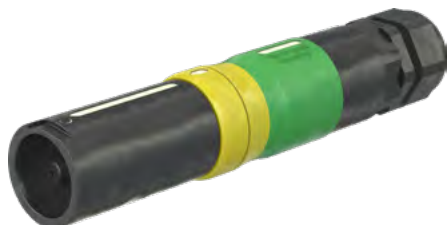

Order No.	Type	Dimensions		Conductor cross-section		Ø-range of the cable gland	Max. Ø conductor	SW of the AxiClamp sleeve	*Colors
		Ø A	C mm ²	C AWG	Ø D mm				
15.0648C... ²⁾ _*	KST10BV-AX/M25/6-16-C... ²⁾	36	6 ³⁾ ; 10 ³⁾ ; 16	10; 8; 6	9 – 18	6	9		
15.0649C... ²⁾ _*	KST10BV-AX/M25/25-35-C... ²⁾	36	25; 35	4; 2	9 – 18	8.5	12	20 21 22 23 24 25	
15.0650C... ²⁾ _*	KST10BV-AX/M25/50-70-C... ²⁾	36	50; 70	1/0; 2/0	9 – 18	12.5	16	26 27 28 29	
15.0651C... ²⁾ _*	KST10BV-AX/M32/50-70-C... ²⁾	46	50; 70	1/0; 2/0	13 – 25	12.5	16		

Accessories (please order separately)

15.5809	VK-S10BV	Protective cover, page 20
15.0138	GS33/42	Open-end spanner to tighten the cable gland, page 23



Assembly instructions MA048

www.staubli.com/electrical

* Please specify the color code

¹⁾ In accordance with IEC 60228 (DIN VDE 0295), see page 55

²⁾ Add code number (C1 up to C5).

³⁾ Increase the outside cable diameter (e.g. with heat shrink tubing) so that the cable gland clamps and seals sufficiently

ACCESSORIES 10BV

Protective covers

Protective covers VK

With retaining strap. Are used to protect unmated connectors from dust and water

splashes. A retaining strap can be used to attach the insulation of the connector.

VK-B10BV



VK-S10BV

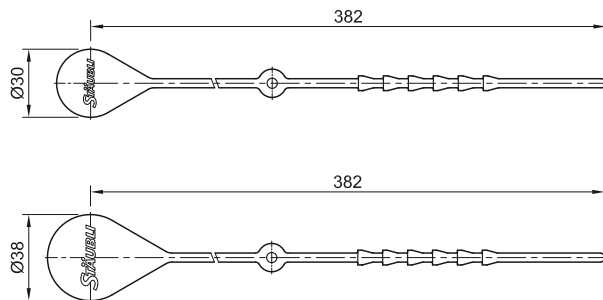

Order No.	Type	Degree of protection	Suitable for	Page	 Assembly instructions
15.5808	VK-B10BV	IP65, IP68	KBT10BV-AX/...	18	MA048
15.5809	VK-S10BV	IP65, IP68	ID/S10BV-... IS10BV-... KST10BV-AX/...	16 17 19	MA046 MA047 MA048

Protective cover PL-PC



For panel receptacle sockets. The protective covers PL-PC-1021SET are spring-loaded hinged covers for covering unmated junc-

tion boxes and protect against mechanical impact, dirt and water spray. Degree of protection IP65

The protective cover can be locked with a padlock (not supplied by Stäubli). The color coding is done with color coding disks.

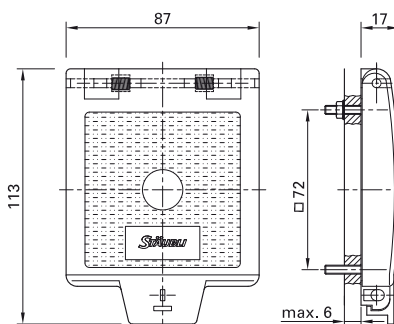
PL-PC-1021SET



Order No.	Type	Suitable for	Page	 Assembly instructions	*Colors
14.5252-*	PL-PC-1021SET	ID/S10BV-C...ID/	16	MA036	

Single parts

14.5137-*	FS-DE10-16	Replacement color coding disks			
-----------	------------	--------------------------------	--	--	---

* Please specify the color code

¹⁾ Not a stock item. Delivery date upon request.

Microswitch

For standard conformity and increased safety

Panel receptacle sockets and surface mounting receptacles can be additionally equipped with a microswitch for connection status indication. The microswitch contact

is a changeover contact with 3 flat terminals 2.8 mm x 0.5 mm and a switching capacity of 6 A, AC 250 V.

The microswitch switches immediately before the lock snaps into place, indicating that the plug connection has been made.

MS-S10BV

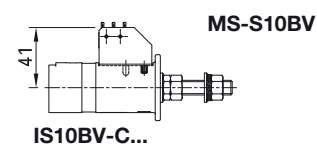
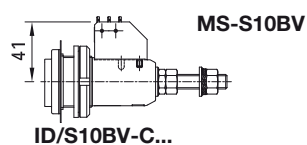
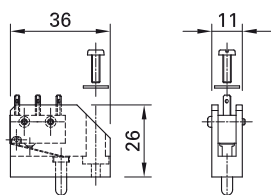

Order No.	Type	Suitable for	Page	 Assembly instructions
14.0103	MS-S10BV	ID/S10BV-... IS10BV-...	16	MA046 MA047



Assembly instructions

www.staubli.com/electrical

Locking ring

With this additional locking ring for mounting on the coupling sockets KBT10BV... the plug connection can be locked in such

a way that it can only be released with the VR10BV-WZ tool.

VR10BV



VR10BV-WZ



Order No.	Type	Description	Suitable for	Page	 MA	Assembly instructions
15.5807	VR10BV	Locking ring	KBT10BV-AX/...	18	MA049	
15.0139	VR10BV-WZ	Tool	VR10BV	22	MA049	

Flat seal

Flat seal. For IP65 mounting of the IS10BV on a surface.

FDK10BV



Order No.	Type	Description	Suitable for	Page	 MA	Assembly instructions
14.5190	FDK10BV	Flat seal	ID/S10BV-C...	16	MA046	



Assembly instructions

www.staubli.com/electrical

TOOLS 10BV

Socket wrench

Stäubli recommends a torque for tightening the ring nut of the 10BV. Stäubli supplies

this socket wrench (SW17) for commercially available torque wrenches.

ID10BV-WZ



Order No.	Type	Torque	Suitable for	Page	 Assembly instructions
14.5189	ID10BV-WZ	10 N m	ID/S10BV-C...	16	MA046

Open-end spanner

For tightening the cable gland of the couplings K...T10BV...Stäubli recommends this tool to prevent overtightening of the threads

when used with conventional tools. For this, two tools are required.

GS33/42



Order No.	Type	Description	Suitable for	Page	 Assembly instructions
15.0138	GS33/42	Open-end spanner (1 piece)	KBT10BV-AX/...	18	MA048
			KST10BV-AX/...	19	MA048



Assembly instructions

www.staubli.com/electrical

OVERVIEW 16BL

Stäubli connectors 16BL

Technical data	
Rated voltage IEC	AC 1000 V/DC 1500 V
Rated voltage, UL	AC 600 V/DC 600 V
Rated current IEC	to 630 A ¹⁾
Rated current, UL	to 380 A ¹⁾
Degree of protection ²⁾ , mated unmated	IP65 ³⁾ , IP68 (1 m, 1 h), IP69 IP2X
Material insulation	PA
Material housing	CuZn (Ag)
Temperature range	-40 °C ... +120 °C
Salt spray test, in accordance with IEC 60068-2-11	672 h continuously
Contact resistance	≤25 μΩ
Short-circuit current, 1 s/3 s	to 14 kA/to 10 kA
Peak withstand current	to 55 A
Test voltage (50 Hz/1 min.)	6.6 kV
Rated impulse voltage, 1.2 μs/50 μs (kV)	12 kV
Overvoltage category/pollution degree	CATIII/3
Shielding	No
Conductor cross-section, crimp connection	70 mm ² – 240 mm ² 2/0 AWG; 500 MCM (incl. 535.3 MCM)
AxiClamp connection	95 mm ² – 240 mm ² 4/0 AWG; 500 MCM
Nominal-Ø pin/socket	16 mm
Withdrawal force/plugging force, when parts are new	114 N/300 N ⁵⁾
Max. Tightening torque	30 N m
Mating cycles	to 5000
Mounting, 16BL-PP/ET/C	Housing and panels, optional with angled adapter
16BL-MP/ET/C	Direct on busbars
Type of termination 16BL-CS/C, 16BL-CP/C 16BL-PP/ET/C 16BL-MP/ET/C	Crimp connection or AxiClamp cable lug busbar/contact block
Locking	Bayonet locking, 45°
Color codes	12
Mechanical codes	C1 to C7
In compliance with	IEC 61984, IEC 60664-1, IEC 60529, IEC 60512-5-2, IEC 61238-1, IEC 60068-2-52, UL 486A-486B, UL 94
UR recognized component	E470532

For additional technical information see
pages 58 – 68

¹⁾ Depending on model – detailed information on pages
58 to 63

²⁾ Depending on the connector combination, in mated condi-
tion or with protective cover

³⁾ Also with protective cover in unmated condition

⁴⁾ Depending on the surface structure of the panel/density of
the installation (only for 16BL-PP/ET/C)

⁵⁾ The value given relates to the first plugging cycle and
decreases progressively with subsequent use

Types and connection options



Notes about coding:

Only plugs with sockets that have the same coding number can be plugged in.
C1 = Standard code



FREE CONNECTORS

Sockets 16BL-CS

With AxiClamp and crimp connection for CU cable class 5 and 6¹⁾

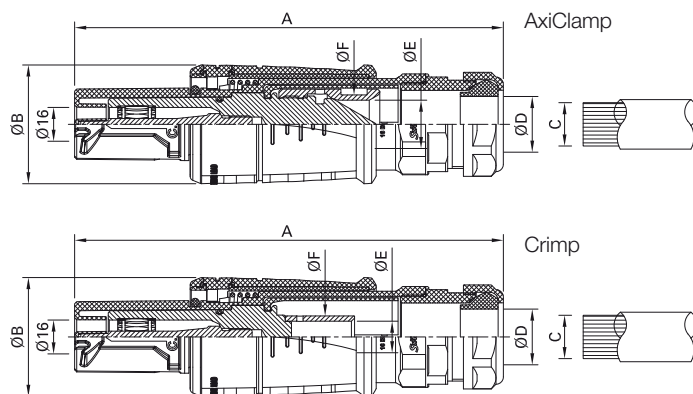

Order No.	Type	Dimensions (mm)		Conductor cross-section			Ø-range of the cable gland	Max. Ø conductor	SW of the AxiClamp sleeve	Crimping sleeve- outside-Ø	*Colors
		A	B	C mm ²	C AWG	C MCM					

AxiClamp connection

15.0718C ²⁾ .*	16BL-CS/AX/M40/95-120-C...	204	57	95 – 120	4/0	250	20 – 32	16	22		20 21 22
15.0719C ²⁾ .*	16BL-CS/AX/M40/150-185-C...	204	57	150 – 185		300 – 350	20 – 32	20	27		23 24 25
15.0720C ²⁾ .*	16BL-CS/AX/M50/150-185-C...	223	57	150 – 185		300 – 350	31 – 41	20	27		26 27 28
15.0721C ²⁾ .*	16BL-CS/AX/M50-240-C...	223	57	240		450 – 500	31 – 41	23	28		29 30 31

Crimp connection

15.0686C ²⁾ .*	16BL-CS/M32/70-C...	202	57	70	2/0		15 – 25	13		17	
15.0687C ²⁾ .*	16BL-CS/M40/95-C...	204	57	95	4/0		20 – 32	15		20	
15.0688C ²⁾ .*	16BL-CS/M40/120-C...	204	57	120		250 (incl. 262.6)	20 – 32	17		22	20 21 22
15.0689C ²⁾ .*	16BL-CS/M40/150-C...	204	57	150		300 (incl. 313.3)	20 – 32	19		25	23 24 25
15.0690C ²⁾ .*	16BL-CS/M40/185-C...	204	57	185		350 (incl. 373.3)	20 – 32	21		27	26 27 28
15.0691C ²⁾ .*	16BL-CS/M50/150-C...	223	57	150		300 (incl. 313.3)	31 – 41	19		25	29 30 31
15.0692C ²⁾ .*	16BL-CS/M50/185-C...	223	57	185		350 (incl. 373.3)	31 – 41	21		27	
15.0693C ²⁾ .*	16BL-CS/M50/240-C...	223	57	240		500 (incl. 535.3)	31 – 41	24		30	

Accessories (please order separately)

15.5881	16BL-CS/PC	Protective cover, page 30
15.5883	16BL-CS/FIX	Fixing band with protective cover, page 31



Assembly instructions MA408

www.staubli.com/electrical

* Please specify the color code

¹⁾ In accordance with IEC 60228 (DIN VDE 0295)

²⁾ Add code number (C1 up to C7)

Plugs 16BL-CP

With AxiClamp and crimp connection for CU cable class 5 and 6¹⁾

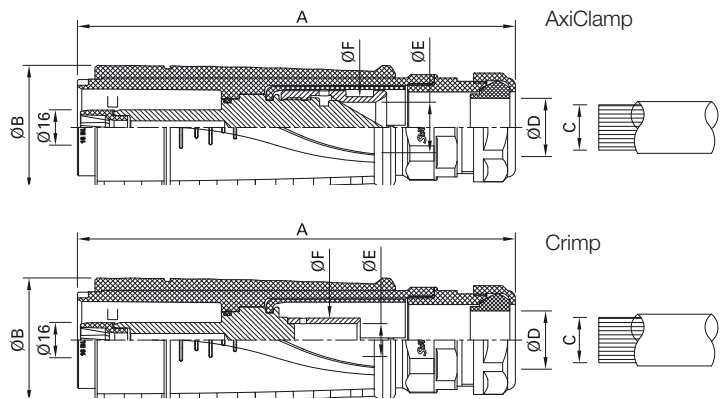

Order No.	Type	Dimensions (mm)		Conductor cross-section			Ø-range of the cable gland	Max. Ø conductor	SW of the AxiClamp sleeve	Crimping sleeve-outside-Ø	*Colors
		A	B	C mm ²	C AWG	C MCM					

AxiClamp connection

15.0722C ²⁾ *	16BL-CP/AX/M40/95-120-C...	200	57	95 – 120	4/0	250	20 – 32	16	22		20 21 22
15.0723C ²⁾ *	16BL-CP/AX/M40/150-185-C...	200	57	150 – 185		300 – 350	20 – 32	20	27		23 24 25
15.0724C ²⁾ *	16BL-CP/AX/M50/150-185-C...	219	57	150 – 185		300 – 350	31 – 41	20	27		26 27 28
15.0725C ²⁾ *	16BL-CP/AX/M50-240-C...	219	57	240		450 – 500	31 – 41	23	28		29 30 31

Crimp connection

15.0702C ²⁾ *	16BL-CP/M32/70-C...	197	57	70	2/0		15 – 25	13		17	
15.0703C ²⁾ *	16BL-CP/M40/95-C...	200	57	95	4/0		20 – 32	15		20	
15.0704C ²⁾ *	16BL-CP/M40/120-C...	200	57	120		250 (incl. 262.6)	20 – 32	17		22	20 21 22
15.0705C ²⁾ *	16BL-CP/M40/150-C...	200	57	150		300 (incl. 313.2)	20 – 32	19		25	23 24 25
15.0706C ²⁾ *	16BL-CP/M40/185-C...	200	57	185		350 (incl. 373.2)	20 – 32	21		27	26 27 28
15.0707C ²⁾ *	16BL-CP/M50/150-C...	219	57	150		300 (incl. 313.2)	31 – 41	19		25	29 30 31
15.0708C ²⁾ *	16BL-CP/M50/185-C...	219	57	185		350 (incl. 373.2)	31 – 41	21		27	
15.0709C ²⁾ *	16BL-CP/M50/240-C...	219	57	240		500 (incl. 535.2)	31 – 41	24		30	

Accessories (please order separately)

15.5882	16BL-CP/PC	Protective cover, page 30
15.5884	16BL-CP/FIX	Fixing band with protective cover, page 31



Assembly instructions MA408

www.staubli.com/electrical

* Please specify the color code

¹⁾ In accordance with IEC 60228 (DIN VDE 0295)

²⁾ Add code number (C1 up to C7)

PANEL RECEPTACLE SOCKET / SURFACE-MOUNTING RECEPTACLE

Plug 16BL-PP/ET

Panel receptacle socket with threaded connection M16

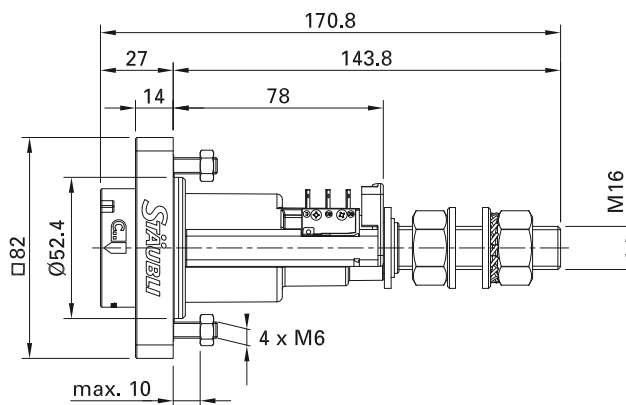

Order No.	Type	Description	*Colors
14.0066C ¹⁾	16BL-PP/ET-C...	Plug with threaded connection M16	

Single parts (please order separately)

14.5204-*	FR21	Color ring	20 21 22 23 24 25 26 27 28 29 30 31
-----------	------	------------	-------------------------------------

Accessories (please order separately)

15.5882	16BL-CP/PC	Protective cover with retaining strap, page 30	
14.5252-*	PL-PC-1021SET	Protective cover with color coding disc, page 30	20 21 22 23 24 25 26 27 28 29 30 31
14.0050	WA-ID/S21	Angled adapter, page 32	
14.0106	MSW-16BL-PP	Microswitch, page 32	



Assembly instructions MA409

www.staubli.com/electrical

* Please specify the color code

¹⁾ Add code number (C1 up to C7)

Plug 16BL-MP/ET

Surface mounting receptacle with threaded connection M16

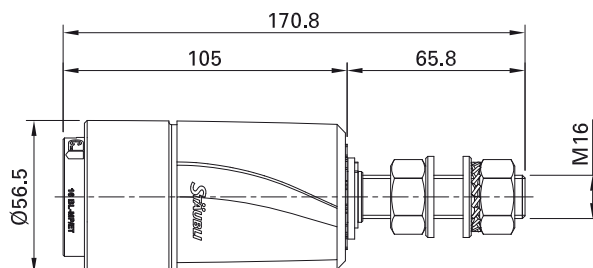

Order No.	Type	Description	*Colors
14.2055C ¹⁾ -*	16BL-MP/ET-C...	Plug with threaded connection M16	

Accessories (please order separately)

15.5882	16BL-CP/PC	Protective cover with retaining strap, page 30
---------	------------	--



Assembly instructions MA410

www.staubli.com/electrical

* Please specify the color code

¹⁾ Add code number (C1 up to C7)

Protective covers

Protective covers 16BL-C.../PC

With retaining strap. Used to protect the unmated connectors from dust and water.

The cover easily attaches to the connector. A retaining strap can be used to attach the protective cover to the insulation of the connector.

16BL-CP/PC

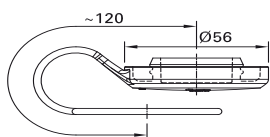

16BL-CS/PC

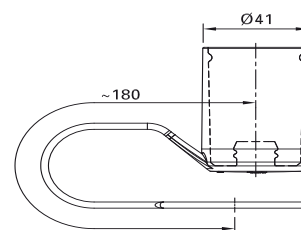

Order No.	Type	Suitable for	Page	Degree of protection	 Assembly instructions
15.5882	16BL-CP/PC	16BL-CP...	27	IP65, IP68	MA408
15.5881	16BL-CS/PC	16BL-CS...	26	IP65, IP68	MA408

Protective cover 16BL-C.../PC

For panel receptacle sockets. The protective covers PL-PC-1021SET are spring-loaded hinged covers for covering unmated junction boxes and protect against mechanical impact, dirt and water spray. Degree of protection IP65

The protective cover can be locked with a padlock (not supplied by Stäubli). The color coding is done with color coding disks.

PL-PC-1021SET

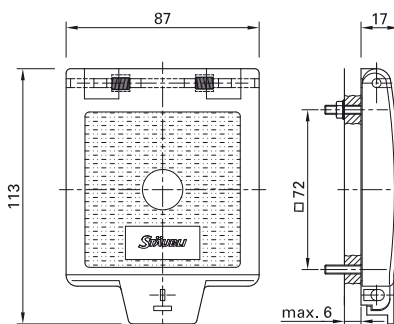

Order No.	Type	Suitable for	Page	Degree of protection	 Assembly instructions	*Colors														
14.5252-*	PL-PC-1021SET	16BL-PP/ET-C...	28	IP65	MA036	<table border="1"> <tr> <td>20</td><td>21</td><td>22</td><td>23</td><td>24</td><td>25</td><td>26</td> </tr> <tr> <td>27</td><td>28</td><td>29</td><td>30¹⁾</td><td>31¹⁾</td><td></td><td></td> </tr> </table>	20	21	22	23	24	25	26	27	28	29	30 ¹⁾	31 ¹⁾		
20	21	22	23	24	25	26														
27	28	29	30 ¹⁾	31 ¹⁾																

Single parts

14.5137-*	FS-DE10-16	Replacement color coding disks				<table border="1"> <tr> <td>20</td><td>21</td><td>22</td><td>23</td><td>24</td><td>25</td><td>26</td> </tr> <tr> <td>27</td><td>28</td><td>29</td><td>30¹⁾</td><td>31¹⁾</td><td></td><td></td> </tr> </table>	20	21	22	23	24	25	26	27	28	29	30 ¹⁾	31 ¹⁾		
20	21	22	23	24	25	26														
27	28	29	30 ¹⁾	31 ¹⁾																

* Please specify the color code

¹⁾ Not a stock item. Delivery date upon request.

Fixing bands with protective cover

For safe and easy attachment of connector 16BL-CP and 16BL-CS by attaching them to the cable reel or other attachment points.

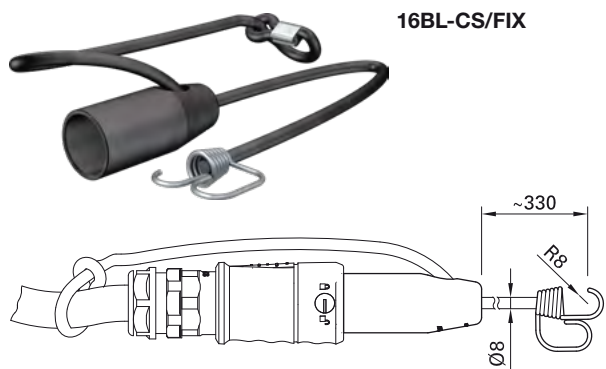
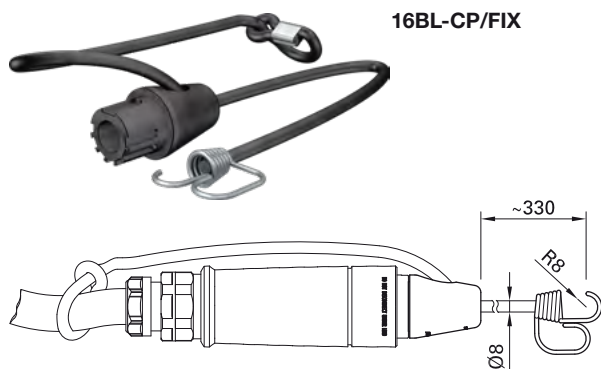

Order No.	Type	Suitable for	Page	 MA	Assembly instructions
15.5884	16BL-CP/FIX	16BL-CP..	27	MA408	
15.5883	16BL-CS/FIX	16BL-CS..	26	MA408	

Microswitch

The use of a locking device (e.g. microswitch) prevents connection under load and ensures that the user complies with the requirements of the IEC 61984 standard.

The 16BL-PP/ET-C can be equipped with a microswitch that indicates the status of the plug-in connection.

The microswitch is a changeover contact with 3 flat terminals 2.8 mm x 0.5 mm. It switches immediately before the lock snaps into place, indicating that the plug connection has been made.

Specified:

- For IEC: 6 A, AC 250 V
- for UL: 5 A, 125/AC 250 V
1 A, DC 48 V

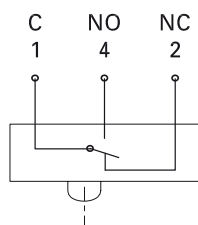

Order No.	Type	Suitable for	Page
14.0106	MSW-16BL-PP	16BL-PP/ET-C... mounted with 2 screws (included in scope of delivery)	28

Angled adapter

The WA-ID/S21 angled adapter is an additional element that enables more space-saving mounting of the ID/S21-C... and 16BL-PP/ET-C... models than the standard version.

It also minimizes the transverse forces caused by the lead that can influence the plug. Degree of protection IP65

Note to IP65:

Please contact Stäubli if the operating altitude exceeds 2000 m above sea level.

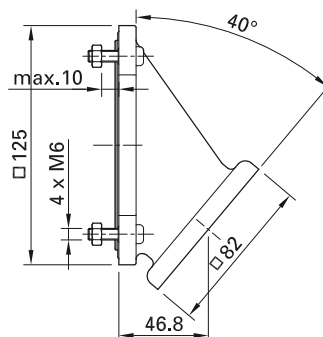

Order No.	Type	Suitable for	Page	Degree of protection	Assembly instructions
14.0050	WA-ID/S21	16BL-PP/ET-C...	28	IP65	MA075

ADAPTER 16BV – 16BL

Compatibility with existing 16BV systems



Integration from a 16BL connector to an existing 16BV system

The 16BL can easily be integrated in an existing system using an adapter solution. Different sets are available for all applications (see page 34.)

Replacement of the 16BV surface mounting sockets connector

The replacement of ID/... connectors with the new 16BL connector is easy and possible without further adjustments. The drilling plan dimensions are identical. Additional mounting screws on the front flange add to stability and reduce the mechanical load after coupling.

Drilling plan 16BV

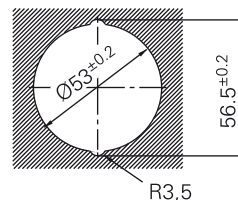

Drilling plan 16BL

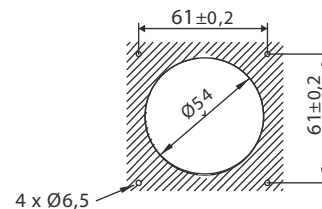

Adapter 16BV – 16BL

Plug-and-Play-Adapter for compatibility with existing 16BV systems

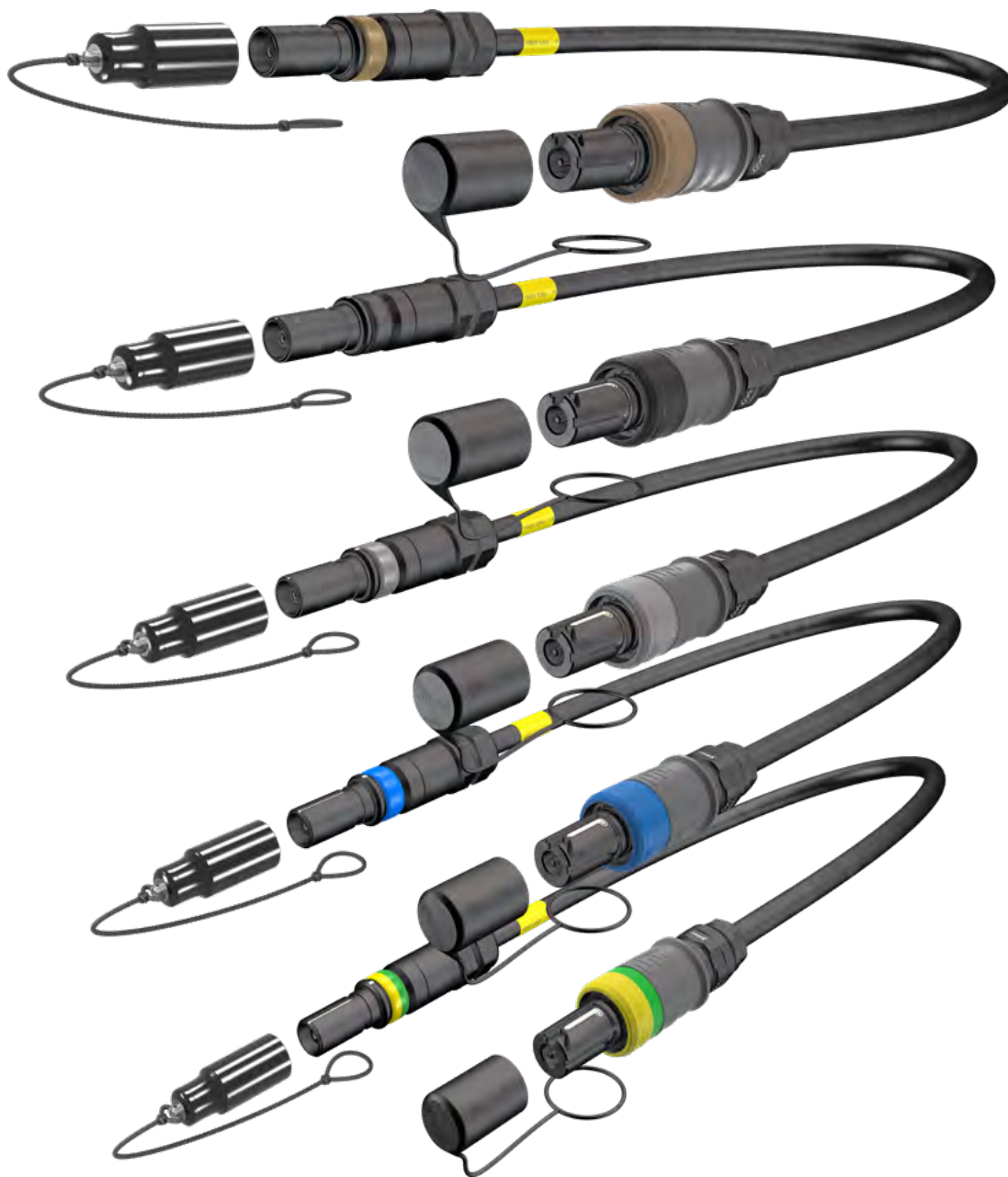

ADAP/16BV/16BL/SET4/EU – set for Europe, type: 16BV plug/16BL plug

Existing 16BV systems can be quickly and easily connected to the new 16BL connectors by using the related plug-and-play adapter.

The right choice for your application must be made according to the configuration of the installation.

Depending on the plug combinations primarily used in the different regions, various adapter sets are available. Each set consists

of the appropriate number of adapters depending on the number of conductors used regionally.

Special versions can be manufactured on request.

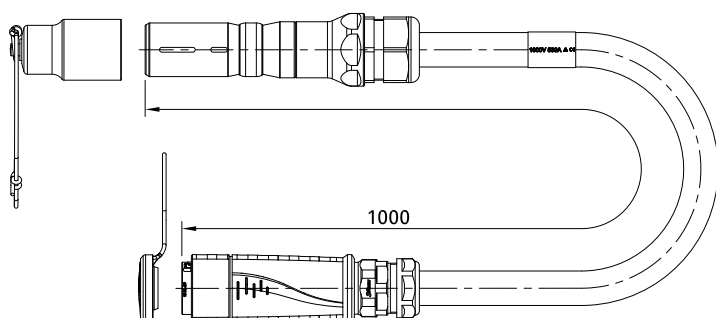

Order No.	Type	Region	Page 16BV		Page 16BL		Conductor/Labeling ¹⁾					Cable length ²⁾	Max. Operating temp.
			Pin	Socket	Pin	Socket	L1	L2	L3	N	PE		
							C1	C2	C3	C4	C5		
15.2553	ADAP/16BV/16BL/SET1/CN	China	x		x		●	●	●	●		1 m	80 °C
15.2554	ADAP/16BV/16BL/SET3/CN			x		x							
15.2555	ADAP/16BV/16BL/SET1/EU	Europe	x		x							1 m	80 °C
15.2556	ADAP/16BV/16BL/SET2/EU			x	x		●	●	●	●	●		
15.2557	ADAP/16BV/16BL/SET3/EU			x		x							
15.2558	ADAP/16BV/16BL/SET4/EU		x			x							
15.2559	ADAP/16BV/16BL/SET1/DE	Germany	x		x							1 m	80 °C
15.2560	ADAP/16BV/16BL/SET2/DE			x	x		●	●	●	●	●		
15.2561	ADAP/16BV/16BL/SET3/DE			x		x							
15.2562	ADAP/16BV/16BL/SET4/DE		x			x							
15.2563	ADAP/16BV/16BL/SET1/CH	Switzerland	x		x							1 m	80 °C
15.2564	ADAP/16BV/16BL/SET2/CH			x	x		●	●	●	●	●		
15.2565	ADAP/16BV/16BL/SET3/CH			x		x							
15.2566	ADAP/16BV/16BL/SET4/CH		x			x							

Note:

Prior to ordering, please check if the cable of the standard-Plug-and-Play-Adapter meets your application conditions.

Criteria such as temperature, chemical resistance or frequency level must be considered with particular care.

If you need assistance, please contact your local Stäubli partner.

¹⁾ Mechanical coding is considered only for the 16BL connectors

²⁾ Pre-assembled, with crimp connection, cable type class PUR 5, cross-section 240 mm²

OVERVIEW 21BV

Stäubli connectors 21BV

Technical data	
Rated voltage IEC	AC 1000 V/DC 1500 V
Rated current IEC	to 1000 A ¹⁾
Degree of protection ^{2) 3)} , mated unmated	IP65, IP68, IP69 IP2X
Material insulation	PA
Material housing	CuZn (Ag)
Temperature range	-60 °C ... +120 °C (static) ⁴⁾⁵⁾
Salt spray test, in accordance with IEC 60068-2-11	672 h continuously
Contact resistance	≤25 μΩ
Short-circuit current, 1 s/3 s	to 19 kA/to 14 kA
Peak withstand current	to 70 kA
Test voltage (50 Hz/1 min.)	6.6 kV
Rated impulse voltage, 1.2 μs/50 μs (kV)	12 kV
Overvoltage category/pollution degree	CATIII/3
Shielding	No
Conductor cross-section crimp connection/screw-on connection	150 mm ² – 400 mm ² 300 MCM – 777 MCM
Nominal-Ø pin/socket	21 mm
Withdrawal force/plugging force, when parts are new	140 N/270 N
Max. Tightening torque	52 N m
Mating cycles	to 5000
Mounting ID/S21BV IS21BV	Housing and panels optional with angled adapter Direct on busbars
Type of termination KST/KBT21BV ID/S21BV IS/21BV	Crimp connection Cable lug Busbar/contact block
Locking	Bayonet locking, 45°
Color codes	12
Mechanical codes	C1 to C6
In compliance with	IEC 61984, IEC 60664-1, IEC 60529, IEC 60512, IEC 60068-2-52, ISO 6988

For additional technical information see
pages 60 – 68

¹⁾ Depending on model – detailed information on pages 60 – 61

²⁾ Depending on the connector combination, in mated condition or with protective cover

³⁾ Depending on the surface structure of the panel/density of the installation (only for ID/S21BV)

⁴⁾ Without mechanical load from handling or impact

⁵⁾ Connection and disconnection to: -40 °C...+90 °C

Types and connection options

Socket



KBT21/M...

Page 40

Pin



KST21/M...

Page 41



ID/S21...

Page 38



IS21...

Page 39

Note about copper (Cu) connectors/for application to 1000 A

Connectors marked with Cu may only be plugged with connectors marked with Cu.



Notes about coding:

Only plugs with sockets that have the same coding number can be plugged in.

C1 = Standard code

PANEL RECEPTACLE SOCKETS 21BV

Plugs ID/S21

With threaded connection M20

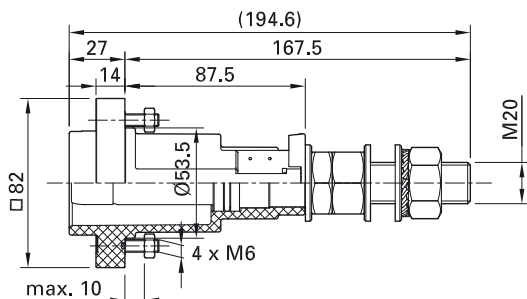

Order No.	Type	Description	Rated current	*Colors
14.0049C... ¹⁾	ID/S21-C... ¹⁾	Pin	800 A	
14.0065C... ¹⁾	ID/S21-C... ¹⁾ CU	Pin	1000 A	

Single parts (please order separately)

14.5204-*	FR21 ²⁾	Color ring		20 21 22 23 24 25 26 27 28 29 30 31
-----------	--------------------	------------	--	-------------------------------------

Accessories (please order separately)

14.5252-*	PL-PC-1021SET	Protective cover with color coding, page 30		20 21 22 23 24 25 26 27 28 29 30 31
14.0104	MS-S21	Microswitch, page 43		
15.5860	VK-S21	Protective cover with retaining strap, page 50		
14.0050	WA-ID/S21	Angled adapter, page 32		



Assembly instructions MA075

www.staubli.com/electrical

* Please specify the color code

¹⁾ Add code number (C1 up to C6) Standard code C1

²⁾ Please order color ring separately

SURFACE MOUNTING RECEPTACLE 21BV

Plug IS21

With threaded connection M20

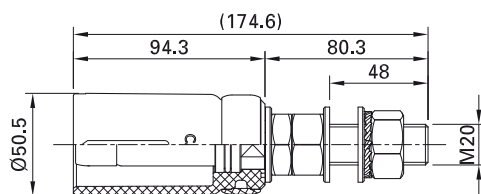

Order No.	Type	*Colored tape
14.2019C... ¹⁾ -*	IS21-C... ¹⁾	20 21 22 23 24 25 26 27 28 29 30 31

Accessories (please order separately)

15.5860	VK-S21	Protective cover with retaining strap, page 50
---------	--------	--



Assembly instructions MA076

www.staubli.com/electrical

* Please specify the color code

¹⁾ Add code number (C1 up to C6) Standard code C1

FREE CONNECTORS 21BV

Sockets KBT21

With crimp connection for CU cable class 5 and 6¹⁾

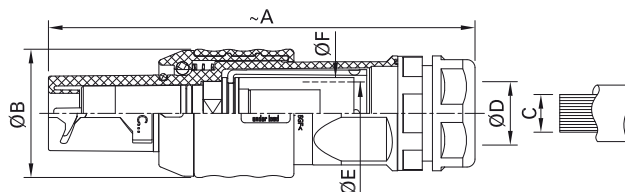

Order No.	Type	Dimensions		Conductor cross-section		Ø-range of the cable gland	Max. Conductor Ø	Crimping sleeve-outside-Ø	*Colors
		~A mm	Ø B mm	C mm ²	C MCM				
15.0668C... ²⁾ *	KBT21/M40/150-C... ²⁾	225	68	150	300	20 – 32	19	25	
15.0669C... ²⁾ *	KBT21/M40/185-C... ²⁾	225	68	185	350	20 – 32	21	27	
15.0670C... ²⁾ *	KBT21/M40/240-C... ²⁾	225	68	240	500	20 – 32	24	30	
15.0671C... ²⁾ *	KBT21/M40/300-C... ²⁾	225	68	300	600	20 – 32	26	32	
15.0672C... ²⁾ *	KBT21/M50/185-C... ²⁾	226	68	185	350	31 – 41	21	27	
15.0673C... ²⁾ *	KBT21/M50/240-C... ²⁾	226	68	240	500	31 – 41	24	30	
15.0674C... ²⁾ *	KBT21/M50/300-C... ²⁾	226	68	300	600	31 – 41	26	32	
15.0675C... ²⁾ *	KBT21/M50/400-C... ²⁾	226	68	400	750	31 – 41	30	38	
15.0684C... ²⁾ *	KBT21/M50/777MCM-C... ²⁾ CU	226	68	400	777	31 – 41	30	38	

Accessories (please order separately)

15.5861	VK-B21	Protective cover, page 42
---------	--------	---------------------------



Assembly instructions MA074

www.staubli.com/electrical

* Please specify the color code

¹⁾ Cable class in accordance with IEC 60228 (DIN VDE 0295), see page 55

²⁾ Add code number (C1 up to C6) Standard code C1

Plugs KST21

With crimp connection CU cable class 5 and 6¹⁾

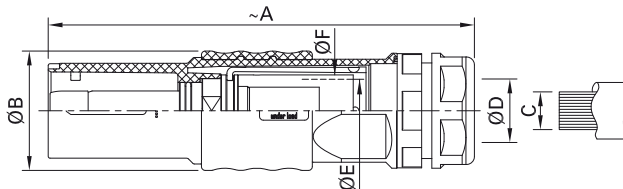

Order No.	Type	Dimensions		Conductor cross-section		Ø-range of the cable gland	Max. Ø conductor	Crimping sleeve-outside-Ø	*Colors
		~A mm	Ø B mm	C mm ²	C MCM				
15.0676C... ²⁾ *	KST21/M40/150-C... ²⁾	225	63	150	300	20 – 32	19	25	
15.0677C... ²⁾ *	KST21/M40/185-C... ²⁾	225	63	185	350	20 – 32	21	27	
15.0678C... ²⁾ *	KST21/M40/240-C... ²⁾	225	63	240	500	20 – 32	24	30	
15.0679C... ²⁾ *	KST21/M40/300-C... ²⁾	225	63	300	600	20 – 32	26	32	
15.0680C... ²⁾ *	KST21/M50/185-C... ²⁾	226	63	185	350	31 – 41	21	27	
15.0681C... ²⁾ *	KST21/M50/240-C... ²⁾	226	63	240	500	31 – 41	24	30	
15.0682C... ²⁾ *	KST21/M50/300-C... ²⁾	226	63	300	600	31 – 41	26	32	
15.0683C... ²⁾ *	KST21/M50/400-C... ²⁾	226	63	400	750	31 – 41	30	38	
15.0685C... ²⁾ *	KST21/M50/777MCM-C... ²⁾ CU	226	63	400	777	31 – 41	30	38	

Accessories (please order separately)

15.5860	VK-S21	Protective cover, page 42
---------	--------	---------------------------



Assembly instructions MA074

www.staubli.com/electrical

* Please specify the color code

¹⁾ Cable class in accordance with IEC 60228 (DIN VDE 0295), see page 55

²⁾ Add code number (C1 up to C6). Standard code C1

ACCESSORIES 21BV

Protective covers for 21BV

Protective cover VK

With retaining strap. Are used to protect unmated connectors from dust and water splashes, protection class IP65 and IP68.

A retaining strap can be used to attach the protective cover to the insulation of the connector.

VK-B21



VK-S21

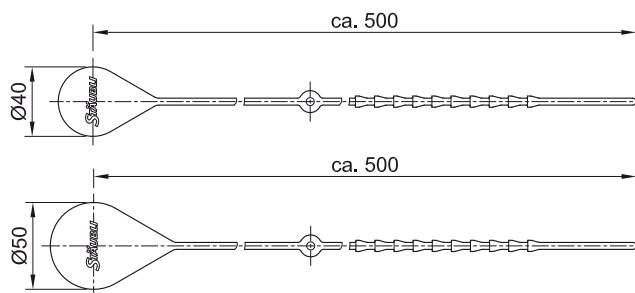

Order No.	Type	Suitable for	Page	Degree of protection	Assembly instructions
15.5861	VK-B21	KBT21/...	40	IP65, IP68	MA074
15.5860	VK-S21	KST21/...	41	IP65, IP68	MA074
		ID/S21...	38		MA075
		IS21...	39		MA076

Protective cover PL-PC

For panel receptacle sockets. The protective covers PL-PC-1021SET are spring-loaded hinged covers for covering unmated junc-

tion boxes and protect against mechanical impact, dirt and water spray. Degree of protection IP65

The protective cover can be locked with a padlock (not supplied by Stäubli). The color coding is done with color coding disks.

PL-PC-1021SET

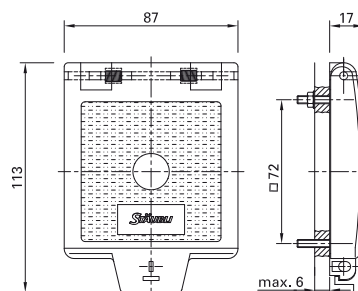

Order No.	Type	Suitable for	Page	Degree of protection	Assembly instructions	*Colors
14.5252-*	PL-PC-1021SET	S21-...	38	IP65	MA036	

Single parts

14.5137-*	FS-DE10-16	Replacement color coding disks				
-----------	------------	--------------------------------	--	--	--	--

* Please specify the color code

¹⁾ Not a stock item. Delivery date upon request.

Angled adapter

The WA-ID/S21 angled adapter is an additional element that enables more space-saving mounting of the ID/S21-C... and 16BL-PP/ET-C... models than the standard version.

It also minimizes the transverse forces caused by the lead that can influence the plug. Degree of protection IP65

Note to IP65:

Please contact Stäubli if the operating altitude exceeds 2000 m above sea level.

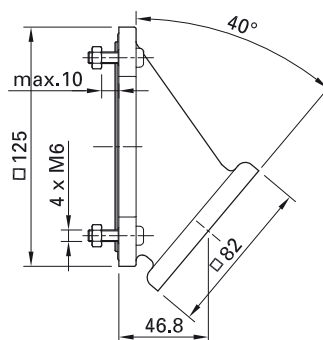

Order No.	Type	Suitable for	Page	Degree of protection	 Assembly instructions
14.0050	WA-ID/S21	ID/S21-C...	38	IP65	MA075

Microswitch for 21BV

Panel receptacle sockets can be additionally equipped with a microswitch for connection status indication. The microswitch

is a changeover contact with 3 flat terminals 2.8 mm x 0.5 mm and a switching capacity of 6 A, AC 250 V.

The microswitch switches immediately before the lock snaps into place, indicating that the connection is closed.

MS-S21

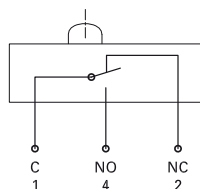

Order No.	Type	Suitable for	Page	 Assembly instructions
14.0104	MS-S21	ID/S21...	38	MA075



Assembly instructions

www.staubli.com/electrical

INTRODUCTION

Shielded connectors

For power supplies with frequency converters, e.g. for driving three-phase motors.

Range of application include, for example, in deep drilling rigs for geothermal drilling and in energy chains of crane systems.

The 16BV-GS connector was developed based on the proven 16BV round connector.

The continuous shielding reliably protects against electromagnetic interference.

The 16BV-GS is IP2X touch protected.

The bayonet lock and color coding ensure secure connection. An optional microswitch

takes over the connection status indication.

In addition to color coding, the 21BV-GS has mechanical coding to prevent incorrect mating (C1...C6); this is especially beneficial in poorly lit working environments. With the 16BV-GS this functionality is offered on request (C1...C6).

With a high operating temperature of 120 °C and a rated current up to 600 A, this connector meets the most demanding application requirements.

Areas of application:

- Drilling equipment
- Automobile testing facilities
- Equipment for test benches
- Railway technology
- Industrial applications in harsh environments such as oil and gas, steel industry, etc.

Technical data	Shielded connector 16BV-GS	Shielded connector 21BV-GS
Rated voltage IEC	AC 1000 V/DC 1500 V	AC 1000 V/DC 1500 V
Rated current IEC	530 A ¹⁾	600 A ¹⁾
Degree of protection ²⁾ , mated unmated	IP65, IP68, IP69 IP2X	IP65, IP67, IP69 IP2X
Material insulation	PA	PA
Material housing	CuZn (Ag)	CuZn (Ag)
Temperature range	-30 ... +90 °C	-40 ... +120 °C
Contact resistance	≤25 μΩ	≤25 μΩ
Short-circuit current, 1 s/3 s	to 14 kA/to 10 kA	to 19 kA/to 14 kA
Peak withstand current	to 55 A	to 70 kA
Test voltage (50 Hz/1 min.)	6.6 kV	6.6 kV
Rated impulse voltage, 1.2 μs/50 μs (kV)	12 kV	12 kV
Overvoltage category/pollution degree	CATIII/3	CATIII/3
Shielding	Al (Ni)	Al (Ni)
Shielding attenuation	to 100 Mhz: 65 dB	to 100 Mhz: 65 dB
Conductor cross section, crimp connection	50 mm ² – 240 mm ²	240 mm – 300 mm ²
Nominal-Ø pin/socket	16 mm	21 mm
Mating cycles	to 5000	to 5000
Mounting ID/B..., ID/S... KST	Housing/front plate (with front ring) or as free connector With cable sets as free connector	
Connection type	Crimp connection	Crimp connection
Locking	Bayonet locking, 90°	Bayonet locking, 45°
Color codes	8	8
Mechanical codes	C1 to C6 (optional, upon request)	C1 to C6
In compliance with	IEC 61984, IEC 60664-1, IEC 60529	IEC 61984, IEC 60664-1, IEC 60529

For additional technical information see
pages 62 – 68

¹⁾ Depending on model – detailed information on pages
62 – 63

²⁾ Depending on the connector combination, in mated condi-
tion, not with microswitch

SHIELDED CONNECTORS 16BV-GS

Panel receptacle sockets ID/B16BV-GS
Plugs KST16BV-GS

For Cu cables class 5^{1) 3)} and 6^{1) 3)}

ID/B16BV-GS-NS/M...

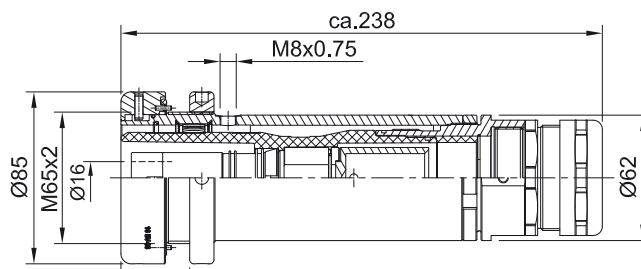

KST16BV-GS-NS/M...

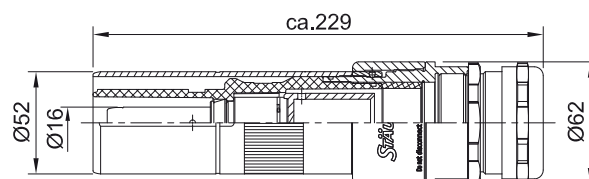

Order No.	Type	Description	Conductor cross-section			*Colors
			mm ²	AWG	MCM	

For flexible cables class 5 ¹⁾

31004803-*	ID/B16BV-GS-NS/M25X1,5-50H	Panel receptacle socket complete with protective cover ²⁾	50	1/0		
31004804-*	ID/B16BV-GS-NS/M32X1,5-70H		70	2/0		
31004805-*	ID/B16BV-GS-NS/M32X1,5-95H		95	4/0		
31004806-*	ID/B16BV-GS-NS/M40X1,5-120H		120		250	
31004807-*	ID/B16BV-GS-NS/M40X1,5-150H		150		300	
31004808-*	ID/B16BV-GS-NS/M40X1,5-185H		185		350	
31004809-*	ID/B16BV-GS-NS/M50X1,5-240H		240		500	
31004796-*	KST16BV-GS-NS/M25X1,5-50H	Plug complete with protective cover ²⁾	50	1/0		
31004797-*	KST16BV-GS-NS/M32X1,5-70H		70	2/0		
31004798-*	KST16BV-GS-NS/M32X1,5-95H		95	4/0		
31004799-*	KST16BV-GS-NS/M40X1,5-120H		120		250	
31004800-*	KST16BV-GS-NS/M40X1,5-150H		150		300	
31004801-*	KST16BV-GS-NS/M40X1,5-185H		185		350	
31004802-*	KST16BV-GS-NS/M50X1,5-240H		240		500	

For flexible cables class 6 ¹⁾

31004786-*	ID/B16BV-GS-NS/M25X1,5-50	Panel receptacle socket complete with protective cover ²⁾	50	1/0		
31004793-*	ID/B16BV-GS-NS/M32X1,5-70		70	2/0		
31004795-*	ID/B16BV-GS-NS/M32X1,5-95		95	4/0		
31004448-*	ID/B16BV-GS-NS/M40X1,5-120		120		250	
31004465-*	ID/B16BV-GS-NS/M40X1,5-150		150		300	
31004447-*	ID/B16BV-GS-NS/M40X1,5-185		185		350	
31004446-*	ID/B16BV-GS-NS/M50X1,5-240		240		500	
31004787-*	ID/KST16BV-GS-NS/M25X1,5-50	Plug complete with protective cover ²⁾	50	1/0		
31004792-*	KST16BV-GS-NS/M32X1,5-70		70	2/0		
31004794-*	KST16BV-GS-NS/M32X1,5-95		95	4/0		
31004445-*	KST16BV-GS-NS/M40X1,5-120		120		250	
31004466-*	KST16BV-GS-NS/M40X1,5-150		150		300	
31004444-*	KST16BV-GS-NS/M40X1,5-185		185		350	
31004443-*	KST16BV-GS-NS/M50X1,5-240		240		500	

Accessories (please order separately)

31004438	DBT-ID/B16BV-GS-NS	Protective cover (replacement), page 50
31004437	DST-KST16BV-GS-NS	Protective cover (replacement), page 50
31004645	MS-ID/B16BV-GS-NS	Microswitch, page 50
31004646	HKS-ID/B16BV-GS-NS	Hook wrench, page 50
	H...16BV-NS	Crimping sleeve, page 53

Assembly instructions MA095
www.staubli.com/electrical

* Please specify the color code

¹⁾ Cable class in accordance with IEC 60228 (DIN VDE 0295), see page 55

²⁾ Not a stock item. Delivery date upon request

³⁾ to 530 A

SHIELDED CONNECTOR 21BV-GS

Sockets KBT21BV-GS

Panel receptacle plugs ID/S21BV-GS

For Cu cables class 5^{1) 2)} and 6^{1) 2)}

KBT21BV-GS/...C...

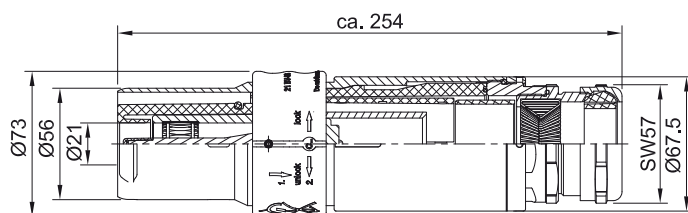

ID/S21BV-GS/...C...

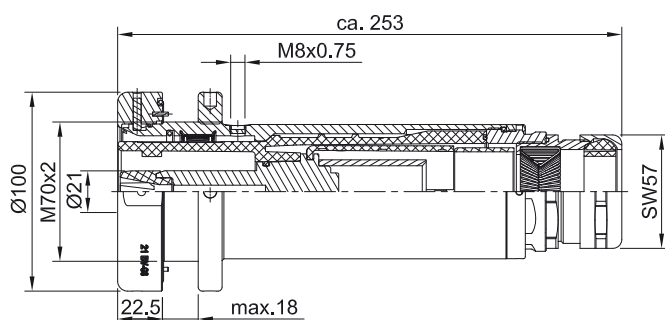
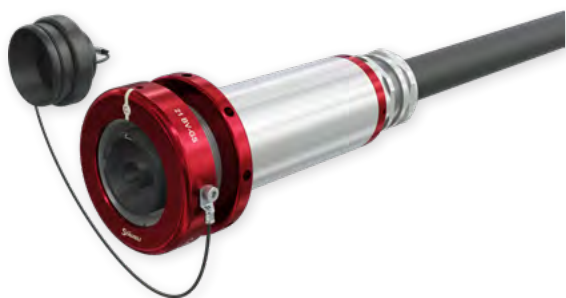

Order No.	Type	Description	Conductor cross-section		*Colors
			mm ²	MCM	
31004923C ³⁾ ...*	KBT21BV-GS/240C...	Socket complete with protective cover ⁴⁾	240	500	
31004772C ³⁾ ...*	KBT21BV-GS/300C...		300	600	
31004975C ³⁾ ...*	ID/S21BV-GS/240C...	Panel receptacle plug complete with protective cover ⁴⁾	240	500	
31004763C ³⁾ ...*	ID/S21BV-GS/300C...		300	600	

Accessories (please order separately)

31004777 ⁴⁾	DBT-KBT21BV-GS	Protective cover (replacement), page 50
31004775 ⁴⁾	DST-ID/S21BV-GS	Protective cover (replacement), page 50
31004645	MS-ID/B16BV-GS-NS	Microswitch, page 50
31004646	HKS-ID/B16BV-GS-NS	Hook wrench, page 50



Assembly instructions MA096

www.staubli.com/electrical

* Please specify the color code

¹⁾ Cable class in accordance with IEC 60228 (DIN VDE 0295), see page 55

²⁾ To 600 A

³⁾ Please add code number (C1 up to C6). Standard code is C1.

⁴⁾ Not a stock item. Delivery date upon request

ACCESSORIES SHIELDED CONNECTORS

Protective covers for 16BV-GS, 21BV-GS

With retaining strap. Used to protect the unmated connectors from dust and water. The cover easily attaches to the connector.

A retaining strap can be used to attach the protective cover to the insulation of the connector.

DST-KST16BV-GS-NS

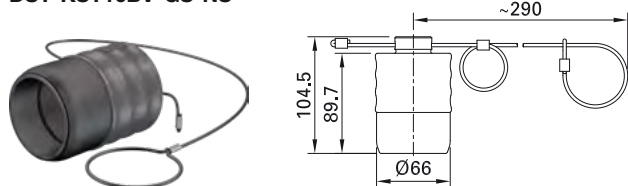

DBT-ID/B16BV-GS-NS

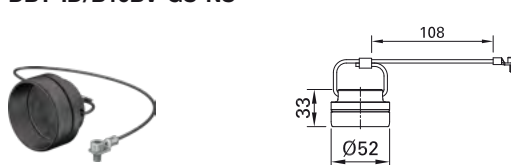

DBT-KBT21BV-GS

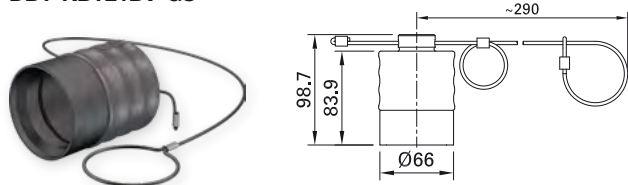

DST-ID/S21BV-GS

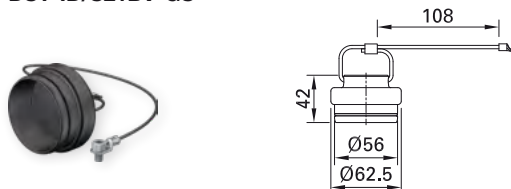

Order No.	Type	Suitable for	Degree of protection	Page	 Assembly instructions
31004437	DST-KST16BV-GS-NS ¹⁾	KST16BV-GS-NS/...	IP65, IP67	47	MA096
31004438	DBT-ID/B16BV-GS-NS ¹⁾	ID/B16BV-GS-NS/...	IP65, IP67	47	MA096
31004777	DBT-KBT21BV-GS ¹⁾	KBT21BV-GS...	IP65, IP67	48	MA096
31004775	DST-ID/S21BV-GS ¹⁾	ID/S21BV-GS...	IP65, IP67	48	MA096

Microswitch for 16BV-GS, 21BV-GS

The microswitch signals the plugged connection.

It has a switching capacity of 1 mA/DC 5 V to 5 A/DC 250 V.

MS-ID/B16BV-GS-NS

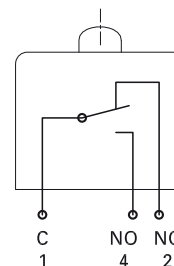

Order No.	Type	Suitable for	Page	 Assembly instructions
31004645	MS-ID/B16BV-GS-NS ¹⁾	ID/B16BV-GS-NS/..., ID/S21BV-GS/...	47 48	MA095 MA096

¹⁾ Not a stock item. Delivery date upon request.

Hook wrench for 16BV-GS, 21BV-GS

Unlike standard hook wrenches, the Stäubli hook wrench ensures damage-free tight-

ening and loosening of anodized fastening nuts due to soft contact surfaces.

With pins according to DIN1810B, Size 80–90.

HKS-ID/B16BV-GS-NS

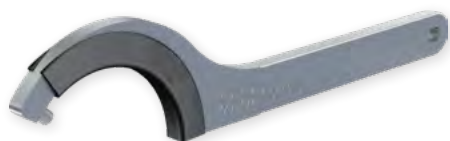

Order No.	Type	Suitable for	Page	 Assembly instructions
31004646	HKS-ID/B16BV-GS-NS	ID/B16BV-GS-NS/...	46	MA095
		ID/S21BV-GS/...	48	MA096

CRIMPING

Crimping

It is recommended to use an ELPRESS hexagonal crimp. The Stäubli crimping sleeves and the dies from ELPRESS are designed for crimping flexible Cu conductors of class

5¹⁾ and 6¹⁾. The crimping tools can be purchased from third-party suppliers.

Elpress V1311-A



Elpress V1311C2-A

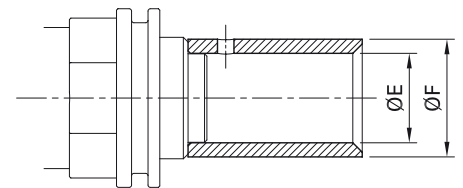
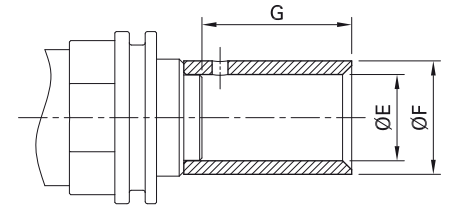

Socket/Pin	Crimping die ²⁾	Conductor cross-section			for cable class ¹⁾ (according to IEC 60228)	Crimping pliers ²⁾	Inner Ø crimping sleeve	Outer Ø crimping sleeve	Crimping sleeve depth	MA Assembly instructions
		mm ²	MCM	AWG						
B+S21/150	13B25	150	300		5/6	Elpress V1311-A	19	25	33	MA077
B+S21/185	13B27	185	350		5/6		21	27	38	
B+S21/240	13B30	240	500		5/6		24	30	42	
B+S21/300	13B32	300	600		5/6		26	32	44	
B+S21/400	13B38	400	750/777		5/6		30	38	51	
S+P-16BL70	B17 (V1330)	70		2/0	5/6	V1311C2-A	13	17		MA408, MA069
S+P-16BL95	B20 (V1330)	95		4/0	5/6		15	20		
S+P-16BL120	B22 (V1330)	120	250 (incl. 262.6)		5/6		17	22		
S+P-16BL150	B25 (V1330)	150	300 (incl. 313.3)		5/6		19	25		
S+P-16BL185	13CB27	185	350 (incl. 373.7)		5/6		21	27		
S+P-16BL240	13CB30	240	500 (incl. 535.3)		5/6		24	30		

¹⁾ Cable class in accordance with IEC 60228 (DIN VDE 0295), see page 55

²⁾ Not delivered by Stäubli.

Notes for crimping with crimping sleeves

For shielded connectors 16BV-GS

Stäubli recommends ELPRESS hexagonal crimping. The dimensions of the crimping sleeves, and the crimping inserts supplied by ELPRESS, are designed for crimping class 6¹⁾ flexible conductors (Purwil).

In response to the increased use of class 5¹⁾ leads with reduced flexibility and therefore a smaller conductor diameter (e.g. H07RN-F), a new range of connectors with a crimping sleeve designed for use with these leads has

been added to our product range. The new crimping sleeves guarantee a perfect connection in terms of both contact resistance and pull-out strength.

Crimping sleeves for sockets and plugs with bayonet locking KBT16BV-NS... and KST16BV-NS... for flexible cables class 5¹⁾ and 6¹⁾

Crimping sleeve



Material: CU-ETP, Ag

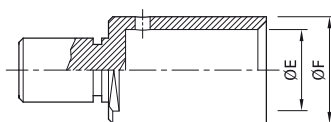

Order No.	Plug type	Conductor cross-section			Inside Ø E mm	Outside Ø F mm	Crimping pliers	Order No. Crimping pliers	Crimping die	Order No. Crimping die	 Assembly instructions
		mm ²	AWG	MCM							

For flexible cables class 6¹⁾

07.0043	H50/16BV-NS	50	1/0		11	14.5	M-PZ-T2600	18.3710	TB11-14,5	18.3713	MA226
07.0044	H70/16BV-NS	70	2/0		13	17	M-PZ-T2600	18.3710	TB8-17	18.3711	
07.0045	H95/16BV-NS	95	4/0		15	20	M-PZ-T2600	18.3710	TB7-20	18.3714	
07.0040	H120/16BV-NS	120		250	17	22	V1311C2-A ²⁾		B22 (V1330) ²⁾		MA069
07.0041	H150/16BV-NS	150		300	19	25	V1311C2-A ²⁾		B25 (V1330) ²⁾		
07.0042	H185/16BV-NS	185		350	21	27	V1311C2-A ²⁾		13CB27 ²⁾		
07.0046	H240/16BV-NS	240		500	24	30	V1311C2-A ²⁾		13CB30 ²⁾		

For flexible cables class 5¹⁾

12.5003	H50-H07RN-F/16BV-NS	50	1/0		10	14	M-PZ-T2600	18.3710	TB12-14 ²⁾		MA226
12.5004	H70-H07RN-F/16BV-NS	70	2/0		12	16	M-PZ-T2600	18.3710	TB10-16	²⁾	
12.5005	H95-H07RN-F/16BV-NS	95	4/0		13.5	18	M-PZ-T2600	18.3710	TB8-18	²⁾	
12.5006	H120-H07RN-F/16BV-NS	120		250	15	19	M-PZ-T2600	18.3710	TB7-19 ²⁾		MA069
12.5007	H150-H07RN-F/16BV-NS	150		300	17	22	V1311C2-A ²⁾		B22 (V1330) ²⁾		
12.5008	H185-H07RN-F/16BV-NS	185		350	19	24	V1311C2-A ²⁾		13CB24 ²⁾		
12.5009	H240-H07RN-F/16BV-NS	240		500	21	26	V1311C2-A ²⁾		13CB26 ²⁾		



Installation tool WKZ16BV-NS-A, page 23

¹⁾ Cable class in accordance with IEC 60228 (DIN VDE 0295), see page 55

²⁾ Not delivered by Stäubli.

³⁾ 2 crimpings required

AxiClamp: a simple and innovative cable connection alternative

The patented cable connection system for electrical and mechanical connection of Cu conductors 6 mm² – 300 mm² class 5 and class 6 according to IEC 60228.

The individual strands of the connecting cable are screwed against a metal cone by means of a conical screw sleeve and clamped tight. The metal cone is part of the contact body. This results in a solid clamp

connection that offers equivalent contact resistances as the crimp connection and has additional advantages.

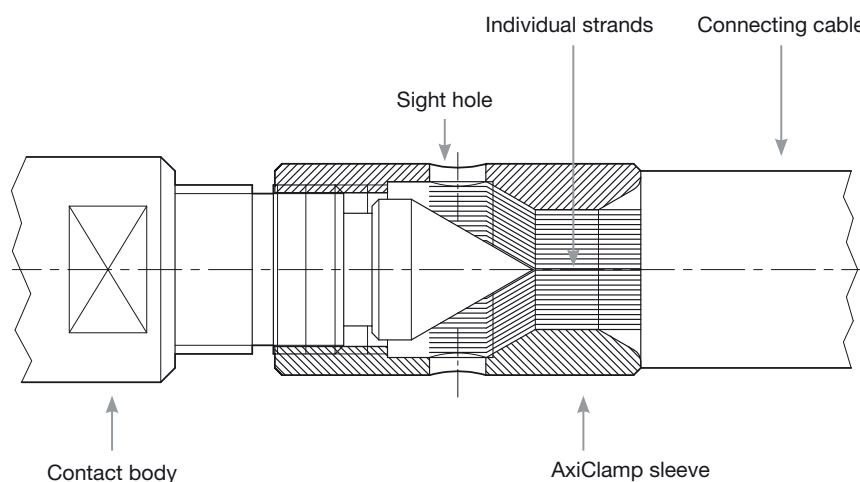

Electrical and thermal tests:

EC 61238-1:2018, (VDE 0220 part 100), compression and screw connectors for power cables for rated voltages up to and including 30 kV ($U_m = 36$ kV)

Mechanical tests:

IEC 60068-2-6:2007-6, environmental tests, Fc tests: Oscillating, sinusoidal.

Test parameter:

- g-strain 10 g
- Amplitude: 0.75 mm
- Frequency: 10 to 500 Hz
- Time: 3 x 112 min.

Benefits of the AxiClamp system

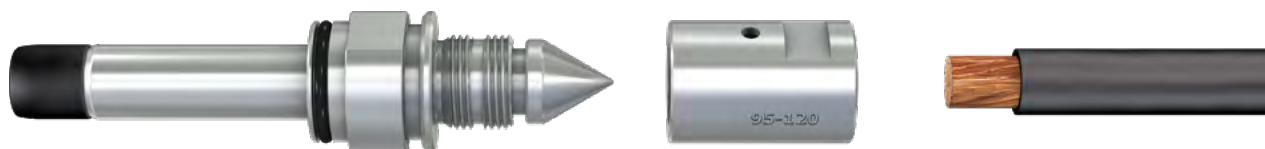

- Possible to mounting with standard tools
- Reusable many times
- Compatible with various cable cross sections
- Time and cost savings



Assembly instructions MA408

www.staubli.com

Choice of connector because of the cable used

The cable must fit the connector during crimp connection, i.e. the Cu single conductors should be held securely in the matching crimp sleeve and the insulation should be permanently fixed in the cable gland. To deal with the different flexible Cu cable

types (class 5 and 6 according to IEC 60228) that are on the market, we have also developed 2 different connector types for the 16BV series.

The difference between class 5 and class 6 is flexibility. Class 6 cables have a higher

flexibility due to the smaller cross-section of the individual strands.

	Flexible conductor, class 5			Flexible conductor, class 6		
	in accordance with IEC 60228 (e.g. H07RN-F)			according to IEC 60228		
Conductor cross-section	largest Ø of the single strands	outside-Ø of the crimping sleeve	inside-Ø of the crimping sleeve	largest Ø of the single strands	outside-Ø of the crimping sleeve	inside-Ø of the crimping sleeve
mm ²	mm	mm	mm	mm	mm	mm
50	0.41	14	10	0.31	14.5	11
70	0.51	16	12	0.31	17	13
95	0.51	18	13.5	0.31	20	15
120	0.51	19	15	0.31	22	17
150	0.51	22	17	0.31	25	19
185	0.51	24	19	0.41	27	21
240	0.51	26	21	0.41	30	24

If the cable type cannot be assigned to classes 5 or 6, the dimensions of the crimp sleeves and cable glands, which are

specified for all connector types, must be matched to the cable data.

Notes to crimping, see page 52.

TECHNICAL DATA

Technical data 10BV connectors

Page	Order No.	Type	General information						
			Connection	Conductor cross-section Cu		Ø-range of the cable gland	Max. Ø conductor	SW of the AxiClamp sleeve	Crimping sleeve-outside-Ø
				mm ²	AWG				
16	14.0048C...	ID/S10BV-C...	Screw (M10)	70	2/0		13		17
17	14.2020C...*	IS10BV-C...	Screw (M10)	70	2/0		13		17
18	15.0644C...*	KBT10BV-AX/M25/6-16-C...	AxiClamp	6 10 16	10 8 6	9 – 18		9	
18	15.0645C...*	KBT10BV-AX/M25/25-35-C...	AxiClamp	25 35	4 2	9 – 18		12	
18	15.0646C...*	KBT10BV-AX/M25/50-70-C...	AxiClamp	50 70	1/0 2/0	9 – 18		16	
18	15.0647C...*	KBT10BV-AX/M32/50-70-C...	AxiClamp	50 70	1/0 2/0	13 – 25		16	
19	15.0648C...*	KST10BV-AX/M25/6-16-C...	AxiClamp	6 10 16	10 8 6	9 – 18		9	
19	15.0649C...*	KST10BV-AX/M25/25-35-C...	AxiClamp	25 35	4 2	9 – 18		12	
19	15.0650C...*	KST10BV-AX/M25/50-70-C...	AxiClamp	50 70	1/0 2/0	9 – 18		16	
19	15.0651C...*	KST10BV-AX/M32/50-70-C...	AxiClamp	50 70	1/0 2/0	13 – 25		16	

* Please specify the color code

¹⁾ The value specified applies only to the connector. The max. rated current must be determined while considering the connected cable. To do this please compare the derating diagram on page 66.

Mechanical data					Electrical characteristics								
Nominal-Ø pin/socket	Withdrawal force	Plugging force	Max. Tightening force	Rated current ¹⁾	Rated voltage		Contact resistance	Short circuit current		Peak withstand current	Test voltage 50 Hz 1 min.	Insulation coordination	
mm	N	N	N m	A	V		<30 µΩ	kA		kA	kV	kV/n	
				IEC	IEC (AC)	IEC (DC)		1s	3s				
10	40	175	10	250	1000	1500		6.0	3.4	25	6.6	8/3	
10	40	175	10	250	1000	1500		6.0	3.4	25	6.6	8/3	
10	40	175	9	50	1000	1500	40	0.8	0.5	2.1	6.6	8/3	
				75	1000	1500	40	1.4	0.8	3.5	6.6	8/3	
				100	1000	1500	40	2.3	1.3	5.6	6.6	8/3	
10	40	175	24	130	1000	1500	40	3.5	2.0	8.8	6.6	8/3	
				150	1000	1500	40	4.9	2.8	12	6.6	8/3	
10	40	175	45	200	1000	1500	40	6.0	3.4	18	6.6	8/3	
				250	1000	1500	40	6.0	3.4	25	6.6	8/3	
10	40	175	45	200	1000	1500	40	6.0	3.4	18	6.6	8/3	
				250	1000	1500	40	6.0	3.4	25	6.6	8/3	
10	40	175	9	50	1000	1500		0.8	0.5	2.1	6.6	8/3	
				75	1000	1500		1.4	0.8	3.5	6.6	8/3	
				100	1000	1500		2.3	1.3	5.6	6.6	8/3	
10	40	175	24	130	1000	1500		4.9	2.0	8.8	6.6	8/3	
				150	1000	1500		4.9	2.8	12	6.6	8/3	
10	40	175	45	200	1000	1500		6.0	3.4	18	6.6	8/3	
				250	1000	1500		6.0	3.4	25	6.6	8/3	
10	40	175	45	200	1000	1500		6.0	3.4	18	6.6	8/3	
				250	1000	1500		6.0	3.4	25	6.6	8/3	

Technical data 16BL connectors

Page	Order No.	Type	General information							
			Connection	Conductor cross-section Cu			Ø-range of the cable gland	Max. Ø conductor	SW of the AxiClamp sleeve	Crimping sleeve-outside-Ø
				mm ²	AWG	MCM				
26	15.0718C...*	16BL-CS/AX/M40/95-120-C...	AxiClamp	95 – 120	4/0	250	20 – 32	16	22	
26	15.0719C...*	16BL-CS/AX/M40/150-185-C...	AxiClamp	150 – 185		300 – 350	20 – 32	20	27	
26	15.0720C...*	16BL-CS/AX/M50/150-185-C...	AxiClamp	150 – 185		300 – 350	31 – 41	20	27	
26	15.0721C...*	16BL-CS/AX/M50-240-C...	AxiClamp	240		450 – 500	31 – 41	23	28	
26	15.0686C...*	16BL-CS/M32/70-C...	Crimp	70	2/0		15 – 25	13		17
26	15.0687C...*	16BL-CS/M40/95-C...	Crimp	95	4/0		20 – 32	15		20
26	15.0688C...*	16BL-CS/M40/120-C...	Crimp	120		250 (incl. 262.6)	20 – 32	17		22
26	15.0689C...*	16BL-CS/M40/150-C...	Crimp	150		300 (incl. 313.3)	20 – 32	19		25
26	15.0690C...*	16BL-CS/M40/185-C...	Crimp	185		350 (incl. 373.3)	20 – 32	21		27
26	15.0691C...*	16BL-CS/M50/150-C...	Crimp	150		300 (incl. 313.3)	31 – 41	19		25
26	15.0692C...*	16BL-CS/M50/185-C...	Crimp	185		350 (incl. 373.3)	31 – 41	21		27
26	15.0693C...*	16BL-CS/M50/240-C...	Crimp	240		500 (incl. 535.3)	31 – 41	24		30
27	15.0722C...*	16BL-CP/AX/M40/95-120-C...	AxiClamp	95 – 120	4/0	250	20 – 32	16	22	
27	15.0723C...*	16BL-CP/AX/M40/150-185-C...	AxiClamp	150 – 185		300-350	20 – 32	20	27	
27	15.0724C...*	16BL-CP/AX/M50/150-185-C...	AxiClamp	150 – 185		300-350	31 – 41	20	27	
27	15.0725C...*	16BL-CP/AX/M50-240-C...	AxiClamp	240		450-500	31 – 41	23	28	
27	15.0702C...*	16BL-CP/M32/70-C...	Crimp	70	2/0		15 – 25	13		17
27	15.0703C...*	16BL-CP/M40/95-C...	Crimp	95	4/0		20 – 32	15		20
27	15.0704C...*	16BL-CP/M40/120-C...	Crimp	120		250 (incl. 262.6)	20 – 32	17		22
27	15.0705C...*	16BL-CP/M40/150-C...	Crimp	150		300 (incl. 313.3)	20 – 32	19		25
27	15.0706C...*	16BL-CP/M40/185-C...	Crimp	185		350 (incl. 373.3)	20 – 32	21		27
27	15.0707C...*	16BL-CP/M50/150-C...	Crimp	150		300 (incl. 313.3)	31 – 41	19		25
27	15.0708C...*	16BL-CP/M50/185-C...	Crimp	185		350 (incl. 373.3)	31 – 41	21		27
27	15.0709C...*	16BL-CP/M50/240-C...	Crimp	240		500 (incl. 535.3)	31 – 41	24		30
28	14.0066C...	16BL-PP/ET-C								
29	14.2055C...*	16BL-MP/ET-C								

* Please specify the color code

¹⁾ The value specified applies only to the connector. The max. rated current must be determined while considering the connected cable. To do this please compare the derating diagram on page 66.

²⁾ The value specified applies only to the largest cross-section of the connector. For smaller cross-sections, please compare the rated current specified for the crimp version, e.g. for a connector 15.0718C...-* used in an IEC application: 500 A with a cable cross-section of 120 mm², 430 A with a cable cross-section of 95 mm².

Mechanical data					Electrical characteristics ¹⁾										
Nominal-Ø pin/socket	Withdrawal force	Plugging force	Max. Tightening torque	Rated current ¹⁾		Rated voltage			Contact resistance	Short-circuit current		Peak withstand current	Test voltage 50 Hz 1 min	Insulation coordination	
				A		V				µΩ	kA				
				IEC ¹⁾	UL	IEC (AC)	IEC (DC)	UL			1 s				3 s
16	114	300		500 ²⁾	255 ²⁾	1000	1500	600	25	14	8.2	55	6.6	12/3	
16	114	300		630 ²⁾	310 ²⁾	1000	1500	600	25	14	10	55	6.6	12/3	
16	114	300		630 ²⁾	310 ²⁾	1000	1500	600	25	14	10	55	6.6	12/3	
16	114	300		630	380	1000	1500	600	25	14	10	55	6.6	12/3	
16	114	300		350	175	1000	1500	600	25	10.4	6	55	6.6	12/3	
16	114	300		430	200	1000	1500	600	25	14	8.2	55	6.6	12/3	
16	114	300		500	255	1000	1500	600	25	14	10	55	6.6	12/3	
16	114	300		580	285	1000	1500	600	25	14	10	55	6.6	12/3	
16	114	300		630	310	1000	1500	600	25	14	10	55	6.6	12/3	
16	114	300		580	285	1000	1500	600	25	14	10	55	6.6	12/3	
16	114	300		630	310	1000	1500	600	25	14	10	55	6.6	12/3	
16	114	300		630	380	1000	1500	600	25	14	10	55	6.6	12/3	
16	114	300		500 ²⁾	255 ²⁾	1000	1500	600	25	14	8.2	55	6.6	12/3	
16	114	300		630 ²⁾	310 ²⁾	1000	1500	600	25	14	10	55	6.6	12/3	
16	114	300		630 ²⁾	310 ²⁾	1000	1500	600	25	14	10	55	6.6	12/3	
16	114	300		630	380	1000	1500	600	25	14	10	55	6.6	12/3	
16	114	300		350	175	1000	1500	600	25	10.4	6	55	6.6	12/3	
16	114	300		430	200	1000	1500	600	25	14	8.2	55	6.6	12/3	
16	114	300		500	255	1000	1500	600	25	14	10	55	6.6	12/3	
16	114	300		580	285	1000	1500	600	25	14	10	55	6.6	12/3	
16	114	300		630	310	1000	1500	600	25	14	10	55	6.6	12/3	
16	114	300		580	285	1000	1500	600	25	14	10	55	6.6	12/3	
16	114	300		630	310	1000	1500	600	25	14	10	55	6.6	12/3	
16	114	300		630	380	1000	1500	600	25	14	10	55	6.6	12/3	
16	114	300	30	630	380	1000	1500	600	25	14	10	55	6.6	12/3	
16	114	300	30	630	380	1000	1500	600	25	14	10	55	6.6	12/3	

Technical data 21BV connectors

Page	Order No.	Type	General information						
			Connection	Conductor cross-section Cu		Ø-range of the cable gland	Max. Ø conductor	SW of the AxiClamp sleeve	Crimping sleeve-outside-Ø
				mm ²	MCM				
38	14.0049C...	ID/S21-C...	Screw (M20)	400	750		30		38
38	14.0065C...	ID/S21-C... CU	Screw (M20)	400	777		30		38
39	14.2019C...*	IS21-C...	Screw (M20)	400	750		30		38
40	15.0668C...*	KBT21/M40/150-C...	Crimp	150	300	20 – 32	19		25
40	15.0669C...*	KBT21/M40/185-C...	Crimp	185	350	20 – 32	21		27
40	15.0670C...*	KBT21/M40/240-C...	Crimp	240	500	20 – 32	24		30
40	15.0671C...*	KBT21/M40/300-C...	Crimp	300	600	20 – 32	26		32
40	15.0672C...*	KBT21/M50/185-C...	Crimp	185	350	31 – 42	21		27
40	15.0673C...*	KBT21/M50/240-C...	Crimp	240	500	31 – 42	24		30
40	15.0674C...*	KBT21/M50/300-C...	Crimp	300	600	31 – 42	26		32
40	15.0675C...*	KBT21/M50/400-C...	Crimp	400	750	31 – 42	30		38
40	15.0684C...*	KBT21/M50/777MCM-C...CU	Crimp	400	777	31 – 42	30		38
41	15.0676C...*	KST21/M40/150-C...	Crimp	150	300	20 – 32	19		25
41	15.0677C...*	KST21/M40/185-C...	Crimp	185	350	20 – 32	21		27
41	15.0678C...*	KST21/M40/240-C...	Crimp	240	500	20 – 32	24		30
41	15.0679C...*	KST21/M40/300-C...	Crimp	300	600	20 – 32	26		32
41	15.0680C...*	KST21/M50/185-C...	Crimp	185	350	31 – 42	21		27
41	15.0681C...*	KST21/M50/240-C...	Crimp	240	500	31 – 42	24		30
41	15.0682C...*	KST21/M50/300-C...	Crimp	300	600	31 – 42	26		32
41	15.0683C...*	KST21/M50/400-C...	Crimp	400	750	31 – 42	30		38
41	15.0685C...*	KST21/M50/777MCM-C...CU	Crimp	400	777	31 – 42	30		38

* Please specify the color code

¹⁾ The value specified applies only to the connector. The max. rated current must be determined while considering the connected cable. To do this please compare the derating diagram on page 66.

Mechanical data					Electrical characteristics								
Nominal-Ø pin/socket	Withdrawal force	Plugging force	Max. Tightening force	Rated current ¹⁾	Rated voltage		Contact resistance	Short circuit current		Peak withstand current	Test voltage 50 Hz 1 min.	Insulation coordination	
mm	N	N	N m	A	V		<30 µΩ	kA		kA	kV	kV/n	
				IEC	IEC (AC)	IEC (DC)		1s	3s				
21	140	270	52	800	1000	1500	13	19	14	70	6.6	12/3	
21	140	270	52	1000	1000	1500	13	19	14	70	6.6	12/3	
21	140	270	52	800	1000	1500	13	19	14	70	6.6	12/3	
21	140	270		400	1000	1500	13	17	10	70	6.6	12/3	
21	140	270		450	1000	1500	13	19	12	70	6.6	12/3	
21	140	270		530	1000	1500	13	19	14	70	6.6	12/3	
21	140	270		600	1000	1500	13	19	14	70	6.6	12/3	
21	140	270		450	1000	1500	13	19	12	70	6.6	12/3	
21	140	270		530	1000	1500	13	19	14	70	6.6	12/3	
21	140	270		600	1000	1500	13	19	14	70	6.6	12/3	
21	140	270		800	1000	1500	13	19	14	70	6.6	12/3	
21	140	270		1000	1000	1500	13	19	14	70	6.6	12/3	
21	140	270		400	1000	1500	13	17	10	70	6.6	12/3	
21	140	270		450	1000	1500	13	19	12	70	6.6	12/3	
21	140	270		530	1000	1500	13	19	14	70	6.6	12/3	
21	140	270		600	1000	1500	13	19	14	70	6.6	12/3	
21	140	270		450	1000	1500	13	19	12	70	6.6	12/3	
21	140	270		530	1000	1500	13	19	14	70	6.6	12/3	
21	140	270		600	1000	1500	13	19	14	70	6.6	12/3	
21	140	270		800	1000	1500	13	19	14	70	6.6	12/3	
21	140	270		1000	1000	1500	13	19	14	70	6.6	12/3	

Technical data shielded connectors 16BV-GS, 21BV-GS

Page	Order No.	Type	General information							
			Connection	Conductor cross-section Cu			Ø-range of the cable gland	Max. Ø conductor	SW of the AxiClamp sleeve	Crimping sleeve-outside-Ø
				mm ²	AWG	MCM				
46	31004448-*	ID/B16BV-GS-NS/M40X1,5-120	Crimp/class6	120		250	15 – 28	15		19
46	31004806-*	ID/B16BV-GS-NS/M40X1,5-120H	Crimp/class5	120		250	15 – 28	15		19
46	31004465-*	ID/B16BV-GS-NS/M40X1,5-150	Crimp/class6	150		300	15 – 28	17		22
46	31004807-*	ID/B16BV-GS-NS/M40X1,5-150H	Crimp/class5	150		300	15 – 28	17		22
46	31004447-*	ID/B16BV-GS-NS/M40X1,5-185	Crimp/class6	185		350	22 – 35	19		24
46	31004808-*	ID/B16BV-GS-NS/M40X1,5-185H	Crimp/class5	185		350	22 – 35	19		24
46	31004446-*	ID/B16BV-GS-NS/M50X1,5-240	Crimp/class6	240		500 (incl. 535.3)	22 – 35	21		26
46	31004809-*	ID/B16BV-GS-NS/M50X1,5-240H	Crimp/class5	240		500 (incl. 535.3)	22 – 35	21		26
46	31004786-*	ID/B16BV-GS-NS/M25X1,5-50	Crimp/class6	50	1/0		15 – 28	10		14
46	31004803-*	ID/B16BV-GS-NS/M25X1,5-50H	Crimp/class5	50	1/0		15 – 28	10		14
46	31004793-*	ID/B16BV-GS-NS/M32X1,5-70	Crimp/class6	70	2/0		15 – 28	12		16
46	31004804-*	ID/B16BV-GS-NS/M32X1,5-70H	Crimp/class5	70	2/0		15 – 28	12		16
46	31004795-*	ID/B16BV-GS-NS/M32X1,5-95	Crimp/class6	95	3/0		15 – 28	13.5		18
46	31004805-*	ID/B16BV-GS-NS/M32X1,5-95H	Crimp/class5	95	3/0		15 – 28	13.5		18
46	31004794-*	KST16BV-GS-NS/M32X1,5-95	Crimp/class6	95	3/0		15 – 28	13.5		18
46	31004799-*	KST16BV-GS-NS/M40X1,5-120H	Crimp/class5	120		250	15 – 28	15		19
46	31004445-*	KST16BV-GS-NS/M40X1,5-120	Crimp/class6	120		250	15 – 28	15		19
46	31004800-*	KST16BV-GS-NS/M40X1,5-150H	Crimp/class5	150		300	15 – 28	17		22
46	31004466-*	KST16BV-GS-NS/M40X1,5-150	Crimp/class6	150		300	15 – 28	17		22
46	31004801-*	KST16BV-GS-NS/M40X1,5-185H	Crimp/class5	185		350	22 – 35	19		24
46	31004444-*	KST16BV-GS-NS/M40X1,5-185	Crimp/class6	185		350	22 – 35	19		24
46	31004802-*	KST16BV-GS-NS/M50X1,5-240H	Crimp/class5	240		500 (incl. 535.3)	22 – 35	21		26
46	31004796-*	KST16BV-GS-NS/M25X1,5-50H	Crimp/class5	50	1/0		15 – 28	10		14
46	31004787-*	ID/KST16BV-GS-NS/M25X1,5-50	Crimp/class6	50	1/0		15 – 28	10		14
46	31004797-*	KST16BV-GS-NS/M32X1,5-70H	Crimp/class5	70	2/0		15 – 28	12		16
46	31004792-*	KST16BV-GS-NS/M32X1,5-70	Crimp/class6	70	2/0		15 – 28	12		16
46	31004798-*	KST16BV-GS-NS/M32X1,5-95H	Crimp/class5	95	3/0		15 – 28	13.5		18
46	31004443-*	KST16BV-GS-NS/M50X1,5-240	Crimp/class6	240		500 (incl. 535.3)	22 – 35	21		26
48	31004923C...-*	KBT21BV-GS/240C...	Crimp	240		500	20 – 32	24		30
48	31004975C...-*	ID/S21BV-GS/240C...	Crimp	240		500	20 – 32	24		30
48	31004772C...-*	KBT21BV-GS/300C...	Crimp	300		600	20 – 32	26		32
48	31004763C...-*	ID/S21BV-GS/300C...	Crimp	300		600	20 – 32	26		32

* Please specify the color code

1) The value specified applies only to the connector. The max.

rated current must be determined while considering the connected cable. To do this please compare the derating

diagram on page 66.

Mechanical data				Electrical characteristics ¹⁾									
Nominal-Ø pin/socket	Withdrawal force	Plugging force	Max. Tightening torque	Rated current ¹⁾	Rated voltage		Contact resistance	Short-circuit current		Peak withstand current	Test voltage 50 Hz 1 min	Insulation coordination	
mm	N	N	N m	A	V		µΩ	kA		kA	kV	kV/n	
				IEC ¹⁾	IEC (AC)	IEC (DC)		1 s	3 s				
16	110	270		340	1000	1500	25	14	8	55	6.6	8/3	
16	110	270		340	1000	1500	25	14	8	55	6.6	8/3	
16	110	270		400	1000	1500	25	14	10	55	6.6	8/3	
16	110	270		400	1000	1500	25	14	10	55	6.6	8/3	
16	110	270		450	1000	1500	25	14	10	55	6.6	8/3	
16	110	270		450	1000	1500	25	14	10	55	6.6	8/3	
16	110	270		530	1000	1500	25	14	10	55	6.6	8/3	
16	110	270		530	1000	1500	25	14	10	55	6.6	8/3	
16	110	270		200	1000	1500	25	5.8	3.3	55	6.6	8/3	
16	110	270		200	1000	1500	25	5.8	3.3	55	6.6	8/3	
16	110	270		250	1000	1500	25	8.1	4.6	55	6.6	8/3	
16	110	270		250	1000	1500	25	8.1	4.6	55	6.6	8/3	
16	110	270		300	1000	1500	25	11	6.3	55	6.6	8/3	
16	110	270		300	1000	1500	25	11	6.3	55	6.6	8/3	
16	110	270		300	1000	1500	25	11	6.3	55	6.6	8/3	
16	110	270		340	1000	1500	25	14	8	55	6.6	8/3	
16	110	270		340	1000	1500	25	14	8	55	6.6	8/3	
16	110	270		400	1000	1500	25	14	10	55	6.6	8/3	
16	110	270		400	1000	1500	25	14	10	55	6.6	8/3	
16	110	270		450	1000	1500	25	14	10	55	6.6	8/3	
16	110	270		450	1000	1500	25	14	10	55	6.6	8/3	
16	110	270		530	1000	1500	25	14	10	55	6.6	8/3	
16	110	270		200	1000	1500	25	5.8	3.3	55	6.6	8/3	
16	110	270		200	1000	1500	25	5.8	3.3	55	6.6	8/3	
16	110	270		250	1000	1500	25	8.1	4.6	55	6.6	8/3	
16	110	270		250	1000	1500	25	8.1	4.6	55	6.6	8/3	
16	110	270		300	1000	1500	25	11	6.3	55	6.6	8/3	
16	110	270		530	1000	1500	25	14	10	55	6.6	8/3	
21	140	270		530	1000	1500	13	19	14	70	6.6	12/3	
21	140	270		530	1000	1500	13	19	14	70	6.6	12/3	
21	140	270		600	1000	1500	13	19	14	70	6.6	12/3	
21	140	270		600	1000	1500	13	19	14	70	6.6	12/3	

Technical data

Extraction and plugging force

Stated values are forces after 20 to 30 actuations and with thin lubricant film. The forces are higher when parts are new.

Tightening torques

The torques apply to clean, lightly greased bolts, nuts and washers.

Rated current (IEC 61984)

Current value determined by Stäubli that the connector can conduct continuously and simultaneously through all its contacts connected to the largest specified conductors (without interruption), at an ambient temperature of 20 °C, without exceeding the upper limiting temperature.

Rated voltage (IEC 61984)

For connectors, the voltage determined by Stäubli to which operating and performance characteristics refer.

Note: A connector may have more than one rated voltage value.

Contact resistance

Is the resistance occurring at the point where two contact areas touch. Its value is calculated using the measured voltage drop at the rated current.

Test voltage

Is the voltage that a connector can withstand under the determined conditions without breakdown or flashover.

Short-circuit current

according to IEC 60909-0:2016

Insulation coordination

In accordance to IEC 60664-1:2007 The values in the tables indicate the rated impulse voltage in kV and the pollution degree.

Initials	Material designation	Temperature
PA	Polyamide	-40 °C...+80 °C
POM	Polyoxymethylene	-40 °C...+100 °C
PA66	Polyamide 66	-30 °C...+120 °C
PA6	Polyamide 6	-30 °C...+90 °C
TPE	Thermoplastic elastomer	-40 °C...+100 °C
PE	Polyethylene	-15 °C...+90 °C
PP	Polypropylene	-15 °C...+90 °C
PVC	Polyvinyl chloride	-15 °C...+80 °C
CR	Neoprene	-20 °C...+80 °C
PUR	Polyurethane	-40 °C...+80 °C

Lubricants

Stäubli recommends the following lubricants:

Grease (general elec. contacts):

- Klübertemp GR UT 18 – 100 g (73.1059)
- Grease in SF6 gas:
- Barrierta I EL-102*

Assembly and sealing grease:

- Barrierta I S-402 or Barrierta I MI-202*

Mating cycles

The maximum mating frequency of the standard connectors is 5000 depending on the operating conditions and when using protective covers in unmated condition. This requires a thin lubricant film on the contacts before the first plugging procedure. Higher mating cycles put stress on the surface, the guide and the lubrication, and always necessitate special clarifications and special versions.

Crimp connection

For conductor connections, we recommend hexagonal crimping for our crimping sleeves. Notching is possible. Our crimping sleeves are designed for highly flexible Cu leads. For other types of leads, special crimping sleeves are required. Stäubli recommends ELPRESS for all highly-flexible Cu conductors.

Note: Stäubli also manufactures fully pre-assembled leads and cables!

Safety instructions

Basic protection against electric shock (IEC 61140:2016)

Hazardous-live-parts shall not be accessible and accessible-conductive-parts shall not be hazardous live either:

- under normal conditions (operation in intended use, and absence of a fault) or
- under single-fault conditions.

Extracts from IEC 61984: 2008 and remarks

1) Plug connectors

Contacts are not under voltage or under load/current when connecting or disconnecting. An electrical or mechanical lock can prevent contacts from becoming live before the connector is plugged in or pulled out. A lock can be obtained with a microswitch.

Protection against electric shock for unenclosed connectors

Protection is ensured by the customer in the final product in which the connectors are installed, or a safety extra-low voltage (SELV) shall be applied.

Protection against electric shock for enclosed connectors

Mated condition: Clearance and creepage distances are measured between live parts and the IEC test probe with a test force of 20 N.

Unmated condition, contact openings: Clearance and creepage distances are considered.

For a plug connector with breaking capacity, clearance and creepage distances are measured through the openings between the live parts and the plane of the mating face.

IEC 61984 “Connectors – Safety requirements and tests”

This international standard applies to connectors with rated voltages from 50 V to 1000 V and rated currents up to 125 A per contact and for which either no detailed specification (DS) exists or for which the DS refers to this standard for safety aspects.

2) Connector system

When connecting or disconnecting, contacts are live only; however, contacts are not under load, and carry no current. Plug devices must have the stated breaking capacity or must be so designed that they can only be connected and disconnected in the absence of load (without current). This can be achieved with a lock, e.g. a microswitch. A microswitch can be installed on the fixed part of the plug connector.

Mated condition: Clearance and creepage distances are measured between live parts and the IEC test probe

Unmated condition: Contact openings: clearance and creepage distances are measured between live parts and the plane of the mating face. Does not apply to the male part of the connector.

3) Connector system (CBC)

(CBC = connector with breaking capacity). Contacts are live and current (load) flows through the contacts when connecting or disconnecting. Stäubli connectors are not suitable for connection or disconnection under load. No breaking capacity can be specified.

Derating diagrams

The current carrying capacity of a connector cannot exceed that of the connected conductor (and vice versa)

The diagrams show the rated current of the respective connectors according to various ambient temperatures.

Derating for electrical machines

If the connectors are used in electrical systems with machines, the IEC 60204-1 (VDE 0113 Part 1) standard "Safety of machines"

is applied instead of VDE 0298-4. This specifies the permissible current-carrying capacity of PVC-insulated copper cables under continuous current in machine use, at

an ambient temperature of 40 °C. For bundled leads and cables, additional reduction factors apply under these conditions.

10BV connectors

Reduction factor 0.9

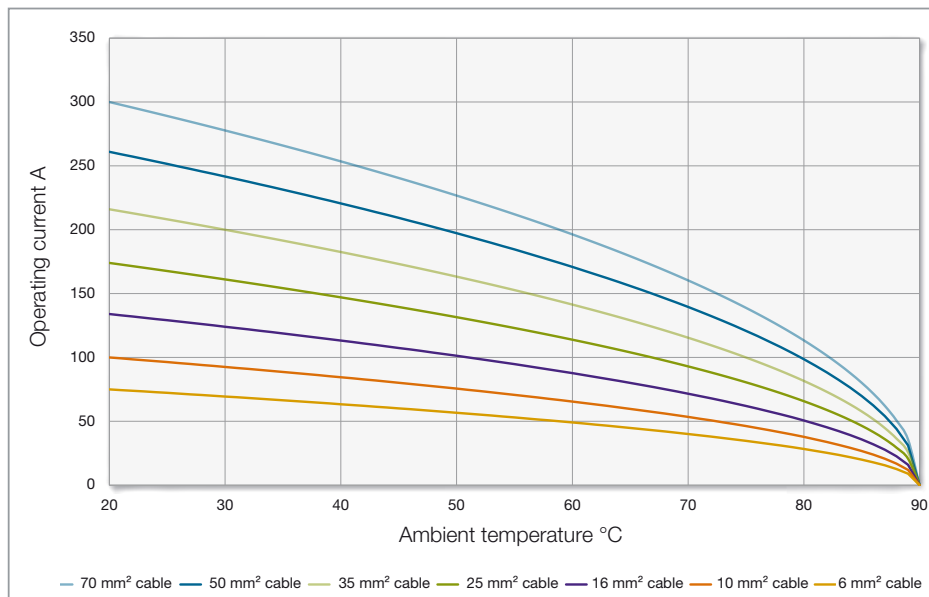

16BL connectors

Reduction factor 0.9

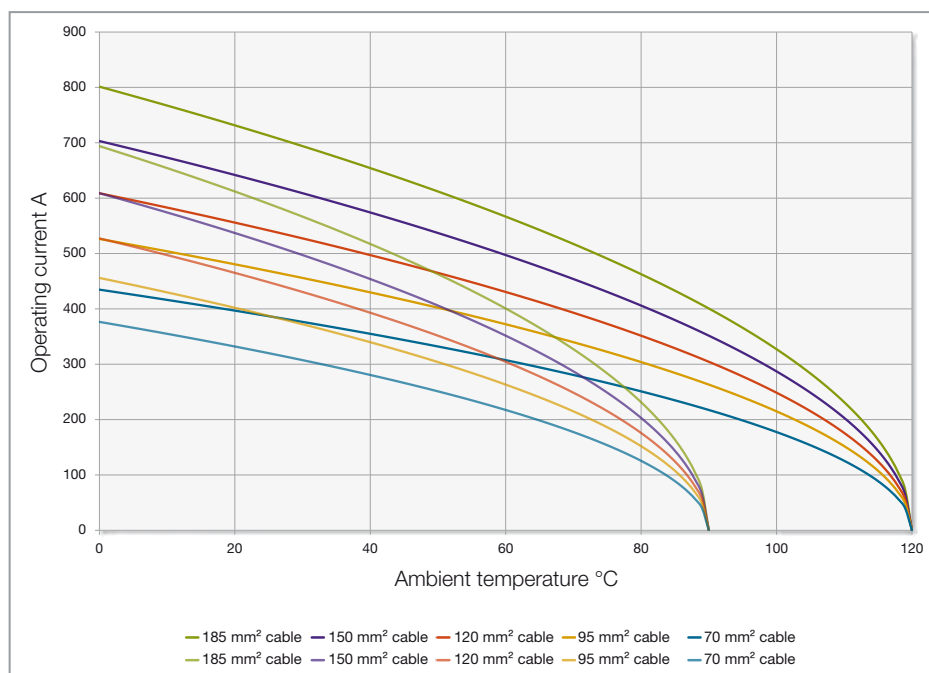

21BV connectors

Reduction factor 0.9

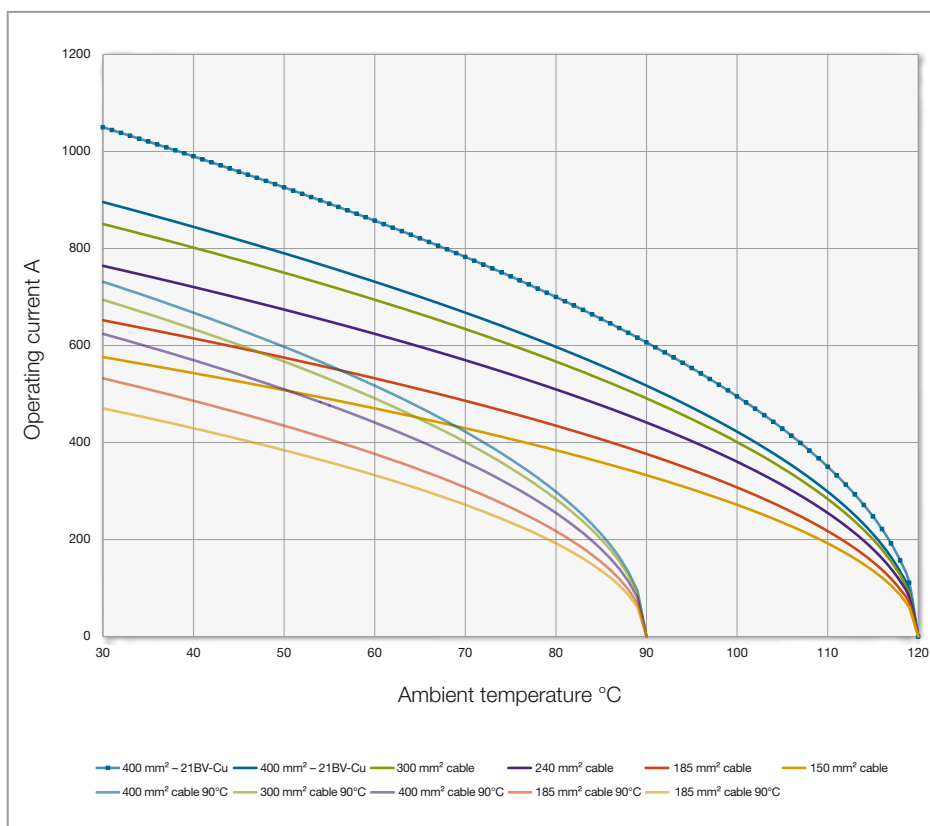

16BV-GS connectors

Reduction factor 0.9

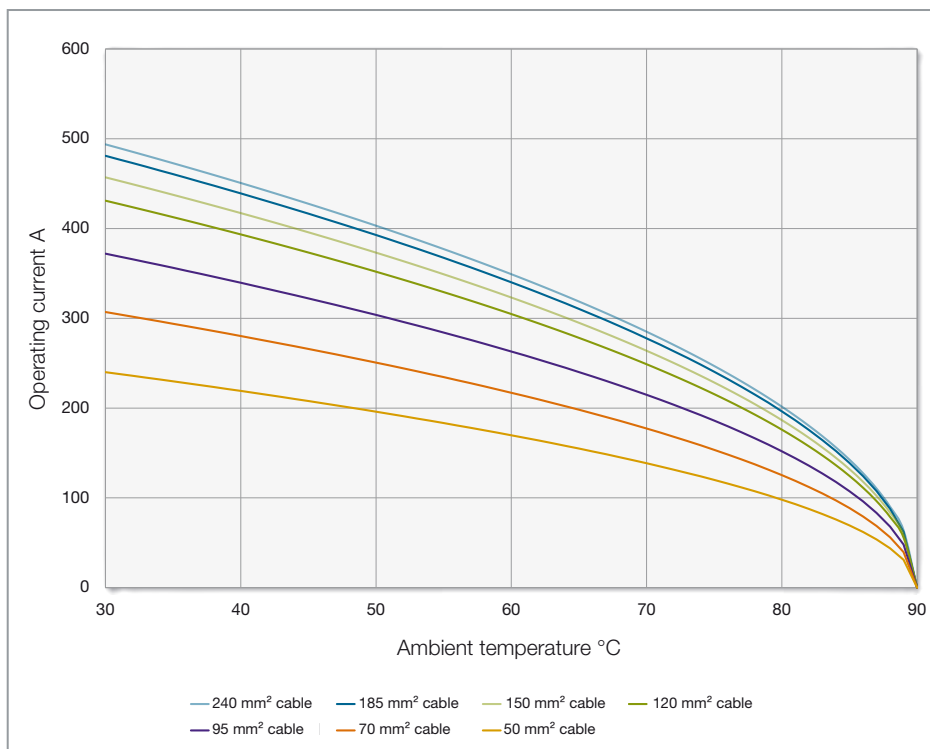

21BV-GS connectors

Reduction factor 0.9

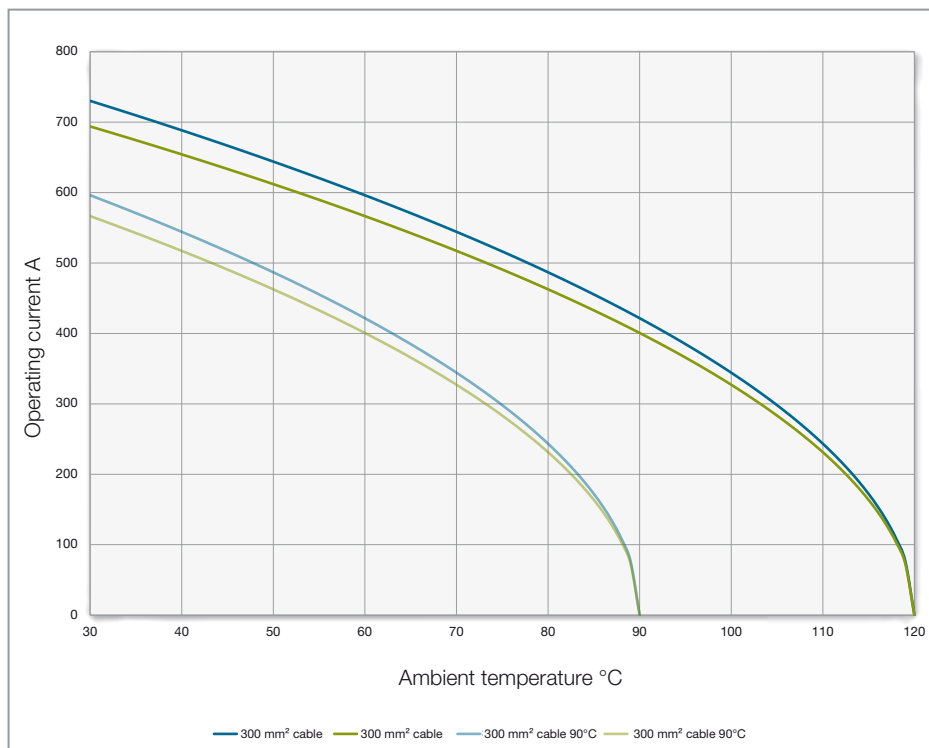

Index

Sorted by type

Type	Page
16BL-CP/AX/M40/95-120-C...	27
16BL-CP/AX/M40/150-185-C...	27
16BL-CP/AX/M50/150-185-C...	27
16BL-CP/AX/M50-240-C...	27
16BL-CP/FIX	31
16BL-CP/M32/70-C...	27
16BL-CP/M40/95-C...	27
16BL-CP/M40/120-C...	27
16BL-CP/M40/150-C...	27
16BL-CP/M40/185-C...	27
16BL-CP/M50/150-C...	27
16BL-CP/M50/185-C...	27
16BL-CP/M50/240-C...	27
16BL-CP/PC	30
16BL-CS/AX/M40/95-120-C...	26
16BL-CS/AX/M40/150-185-C...	26
16BL-CS/AX/M50/150-185-C...	26
16BL-CS/AX/M50-240-C...	26
16BL-CS/FIX	31
16BL-CS/M32/70-C...	26
16BL-CS/M40/95-C...	26
16BL-CS/M40/120-C...	26
16BL-CS/M40/150-C...	26
16BL-CS/M40/185-C...	26
16BL-CS/M50/150-C...	26
16BL-CS/M50/185-C...	26
16BL-CS/M50/240-C...	26
16BL-CS/PC	30
16BL-MP/ET-C...	29
16BL-PP/ET-C...	28
ADAP/16BV/16BL/SET1/CH	35
ADAP/16BV/16BL/SET1/CN	35
ADAP/16BV/16BL/SET1/DE	35
ADAP/16BV/16BL/SET1/EU	35
ADAP/16BV/16BL/SET2/CH	35
ADAP/16BV/16BL/SET2/DE	35
ADAP/16BV/16BL/SET2/EU	35
ADAP/16BV/16BL/SET3/CH	35
ADAP/16BV/16BL/SET3/CN	35
ADAP/16BV/16BL/SET3/DE	35
ADAP/16BV/16BL/SET3/EU	35
ADAP/16BV/16BL/SET4/CH	35
ADAP/16BV/16BL/SET4/DE	35

Type	Page
ADAP/16BV/16BL/SET4/EU	35
DBT-ID/B16BV-GS-NS	49
DBT-KBT21BV-GS	49
DST-ID/S21BV-GS	49
DST-KST16BV-GS-NS	49
FDK10BV	17, 22
FR10	16
FR21	28, 38
FS-DE10-16	20, 30, 42
GS33/42	23
H50/16BV-NS	53
H50-H07RN-F/16BV-NS	53
H70/16BV-NS	53
H70-H07RN-F/16BV-NS	53
H95/16BV-NS	53
H95-H07RN-F/16BV-NS	53
H120/16BV-NS	53
H120-H07RN-F/16BV-NS	53
H150/16BV-NS	53
H150-H07RN-F/16BV-NS26	53
H185/16BV-NS	53
H185-H07RN-F/16BV-NS	53
H240/16BV-NS	53
H240-H07RN-F/16BV-NS	53
HKS-ID/B16BV-GS-NS	50
ID10BV-WZ	16, 23
ID/B16BV-GS-NS/M25X1.5-50	47
ID/B16BV-GS-NS/M25X1.5-50H	47
ID/B16BV-GS-NS/M32X1.5-70	47
ID/B16BV-GS-NS/M32X1.5-70H	47
ID/B16BV-GS-NS/M32X1.5-95	47
ID/B16BV-GS-NS/M32X1.5-95H	47
ID/B16BV-GS-NS/M40X1.5-120	47
ID/B16BV-GS-NS/M40X1.5-120H	47
ID/B16BV-GS-NS/M40X1.5-150	47
ID/B16BV-GS-NS/M40X1.5-150H	47
ID/B16BV-GS-NS/M40X1.5-185	47
ID/B16BV-GS-NS/M40X1.5-185H	47
ID/B16BV-GS-NS/M50X1.5-240	47
ID/B16BV-GS-NS/M50X1.5-240H	47
ID/S10BV-C...	16, 56
ID/S21BV-GS/240C...	48
ID/S21BV-GS/300C...	48

Type	Page
ID/S21-C...	38, 61
ID/S21-C... CU	38, 61
IS10BV-C...	17, 56
IS21-C...	39, 61
KBT10BV-AX/M25/6-16-C...	18, 56
KBT10BV-AX/M25/25-35-C...	18, 56
KBT10BV-AX/M25/50-70-C...	18, 19, 56
KBT10BV-AX/M32/50-70-C...	18, 56
KBT21BV-GS/240C...	48
KBT21BV-GS/300C...	48
KBT21/M40/150-C...	40, 61
KBT21/M40/185-C...	40, 61
KBT21/M40/240-C...	40, 61
KBT21/M40/300-C...	40, 61
KBT21/M50/185-C...	40, 61
KBT21/M50/240-C...	40, 61
KBT21/M50/300-C...	40, 61
KBT21/M50/400-C...	40, 61
KBT21/M50/777MCM-C... CU	40
KBT21/M50/777MCM-C...CU	61
KST10BV-AX/M25/6-16-C...	19, 56
KST10BV-AX/M25/25-35-C...	19, 56
KST10BV-AX/M25/50-70-C...	56
KST10BV-AX/M32/50-70-C...	19, 56
ID/KST16BV-GS-NS/M25X1.5-50	47
KST16BV-GS-NS/M25X1.5-50H	47
KST16BV-GS-NS/M32X1.5-70	47
KST16BV-GS-NS/M32X1.5-70H	47
KST16BV-GS-NS/M32X1.5-95	47
KST16BV-GS-NS/M32X1.5-95H	47
KST16BV-GS-NS/M40X1.5-120	47
KST16BV-GS-NS/M40X1.5-120H	47
KST16BV-GS-NS/M40X1.5-150	47
KST16BV-GS-NS/M40X1.5-150H	47
KST16BV-GS-NS/M40X1.5-185	47
KST16BV-GS-NS/M40X1.5-185H	47
KST16BV-GS-NS/M50X1.5-240	47
KST16BV-GS-NS/M50X1.5-240H	47
KST21/M40/150-C...	41, 61
KST21/M40/185-C...	41, 61
KST21/M40/240-C...	41, 61
KST21/M40/300-C...	41, 61
KST21/M50/185-C...	41, 61

Type	Page
KST21/M50/240-C...	41, 61
KST21/M50/300-C...	41, 61
KST21/M50/400-C...	41, 61
KST21/M50/777MCM-C... CU	41
KST21/M50/777MCM-C...CU	61
MS-ID/B16BV-GS-NS	49
MS-S10BV	21

Type	Page
MS-S21	43
MSW-16BL-PP	32
PL-PC-1021SET	20, 30, 42
VK-B10BV	20
VK-B21	42
VK-S10BV	20
VK-S21	42

Type	Page
VR10BV	22
VR10BV-WZ	22
WA-ID/S21	32

Sorted by Order No.

Order No.	Page
07.0040	53
07.0041	53
07.0042	53
07.0043	53
07.0044	53
07.0045	53
07.0046	53
12.5003	53
12.5004	53
12.5005	53
12.5006	53
12.5007	53
12.5008	53
12.5009	53
14.0048C...	16, 56
14.0049C...	38, 61
14.0050	32
14.0065C...	38, 61

Order No.	Page
14.0066C	28
14.0103	21
14.0104	43
14.0106	32
14.2019C...-*	39, 61
14.2020C...-*	17, 56
14.2055C...-*	29
14.5137-*	20, 30, 42
14.5187-*	16
14.5189	16, 23
14.5190	17, 22
14.5204-*	28, 38
14.5252	20, 30, 42
15.0138	23
15.0139	22
15.0644C...-*	18, 56
15.0645C...-*	18, 56
15.0646C...-*	18, 19, 56

Order No.	Page
15.0647C...-*	18, 56
15.0648C...-*	19, 56
15.0649C...-*	19, 56
15.0650C...-*	56
15.0651C...-*	19, 56
15.0668C...-*	40, 61
15.0669C...-*	40, 61
15.0670C...-*	40, 61
15.0671C...-*	40, 61
15.0672C...-*	40, 61
15.0673C...-*	40, 61
15.0674C...-*	40, 61
15.0675C...-*	40, 61
15.0676C...-*	41, 61
15.0677C...-*	41, 61
15.0678C...-*	41, 61
15.0679C...-*	41, 61
15.0680C...-*	41, 61

Order No.	Page
15.0681C...-*	41, 61
15.0682C...-*	41, 61
15.0683C...-*	41, 61
15.0684C...-*	40
15.0684C...*	61
15.0685C...-*	41
15.0685C...*	61
15.0686C...-*	26
15.0687C...-*	26
15.0688C...-*	26
15.0689C...-*	26
15.0690C...-*	26
15.0691C...-*	26
15.0692C...-*	26
15.0693C...-*	26
15.0702C...-*	27
15.0703C...-*	27
15.0704C...-*	27
15.0705C...-*	27
15.0706C...-*	27
15.0707C...-*	27
15.0708C...-*	27
15.0709C...-*	27
15.0718C...-*	26
15.0719C...-*	26
15.0720C...-*	26
15.0721C...-*	26
15.0722C...-*	27
15.0723C...-*	27
15.0724C...-*	27
15.0725C...-*	27
15.2553	35
15.2554	35
15.2555	35
15.2556	35
15.2557	35
15.2558	35
15.2559	35
15.2560	35
15.2561	35
15.2562	35
15.2563	35
15.2564	35
15.2565	35

Order No.	Page
15.2566	35
15.5807	22
15.5808	20
15.5809	20
15.5860	42
15.5861	42
15.5881	30
15.5882	30
15.5883	31
15.5884	31
31004437	49
31004438	49
31004443-*	47
31004444-*	47
31004445-*	47
31004446-*	47
31004447-*	47
31004448-*	47
31004465-*	47
31004466-*	47
31004645	49
31004646	50
31004763C...-*	48
31004772C...-*	48
31004775	49
31004777	49
31004786-*	47
31004787-*	47
31004792-*	47
31004793-*	47
31004794-*	47
31004795-*	47
31004796-*	47
31004797-*	47
31004798-*	47
31004799-*	47
31004800-*	47
31004801-*	47
31004802-*	47
31004803-*	47
31004804-*	47
31004805-*	47
31004806-*	47
31004807-*	47

Order No.	Page
31004808-*	47
31004809-*	47
31004923C...-*	48
31004975C...-*	48



● Stäubli Units ○ Representatives/Agents

Global presence of the Stäubli Group

www.staubli.com